

MOBILIER



MOBILIER

Comptoir 1 - #150

Comptoir
1m x 0.5m x 42''

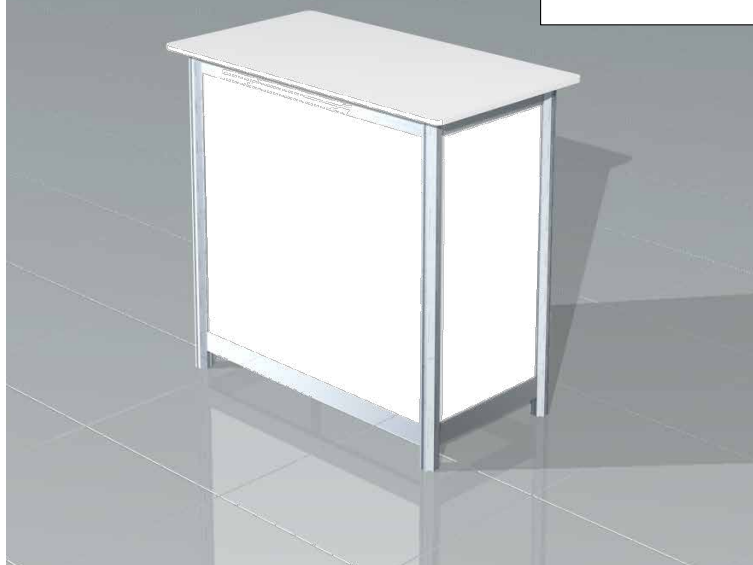
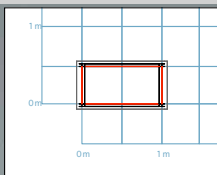

Comptoir 2 - #155

Podium 0.5m x 0.5m
Hauteur : 14'', 24'', 30'' et 42''

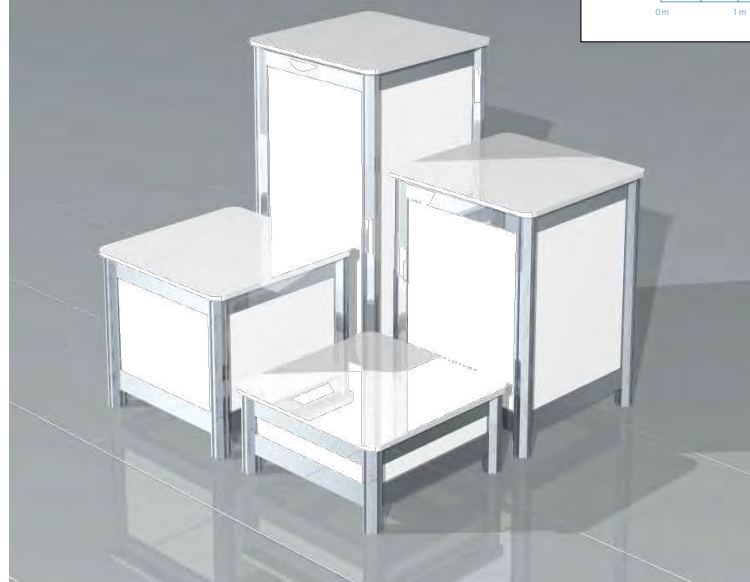
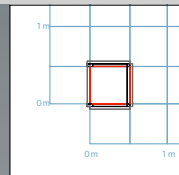

Comptoir 3 - #153

Comptoir vitré dessus
1m x 0.5m x 42''

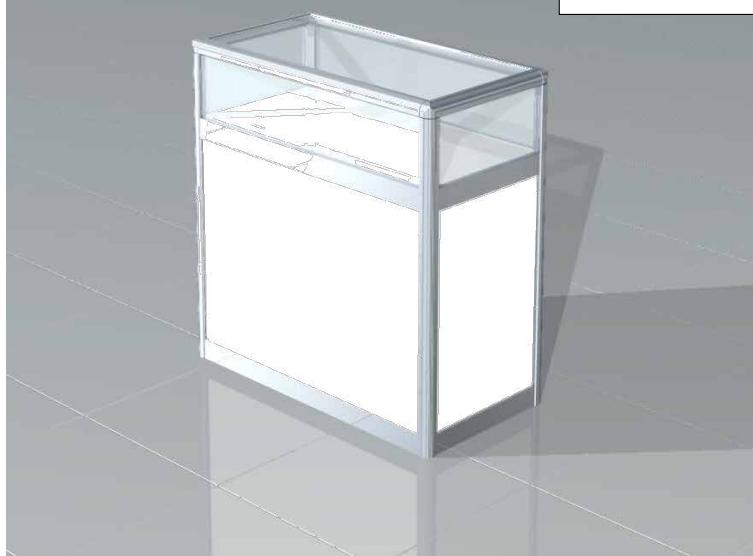
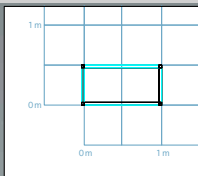

Comptoir 4 - #152

Comptoir vitré 2/3
1m x 0.5m x 42''

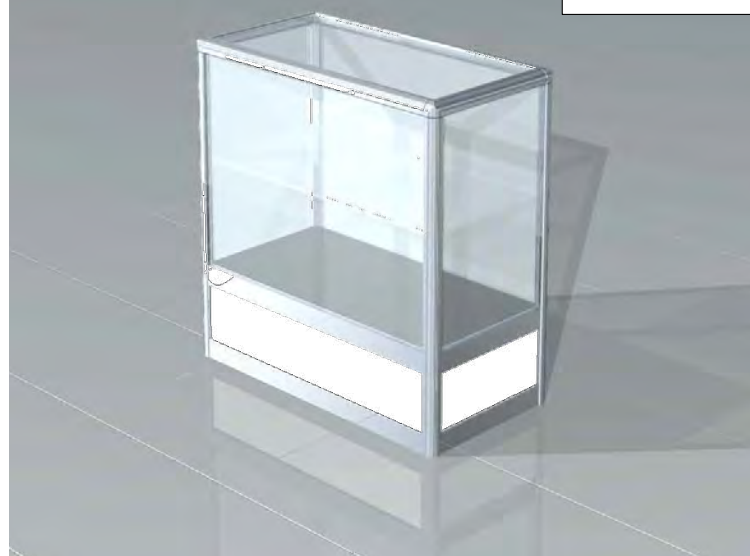
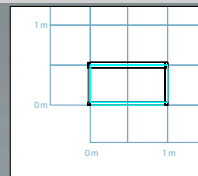

MOBILIER

Comptoir 5

Comptoir en coin
0.5mdr x 42''

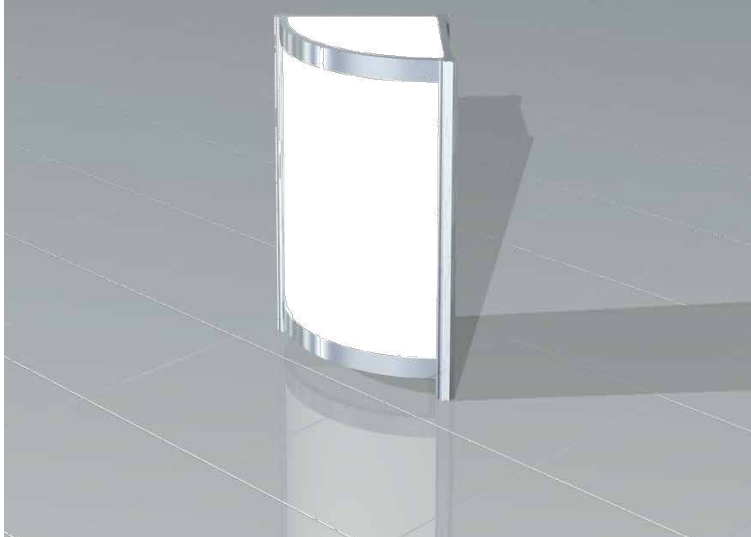
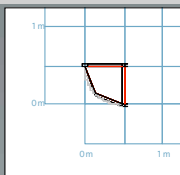

Comptoir 6 - #158

Comptoir arrondi
1mdr x 42''

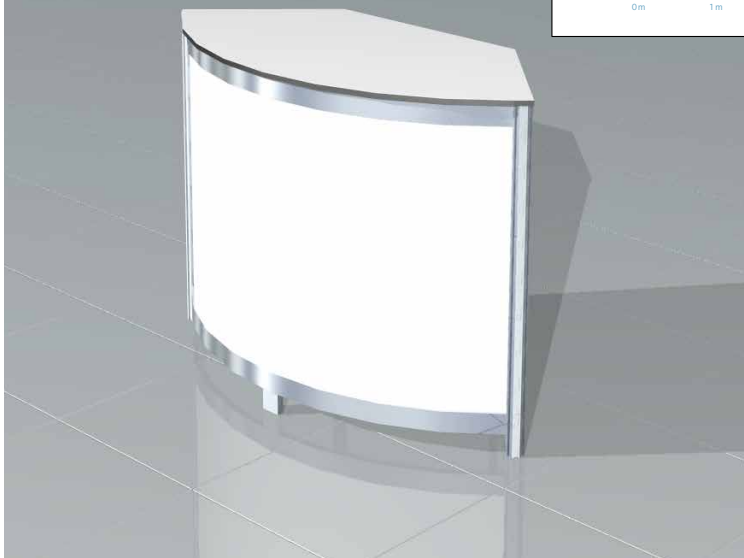
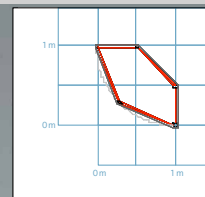

Comptoir 7 - #157

Comptoir vitré dessus
1mdr x 42''

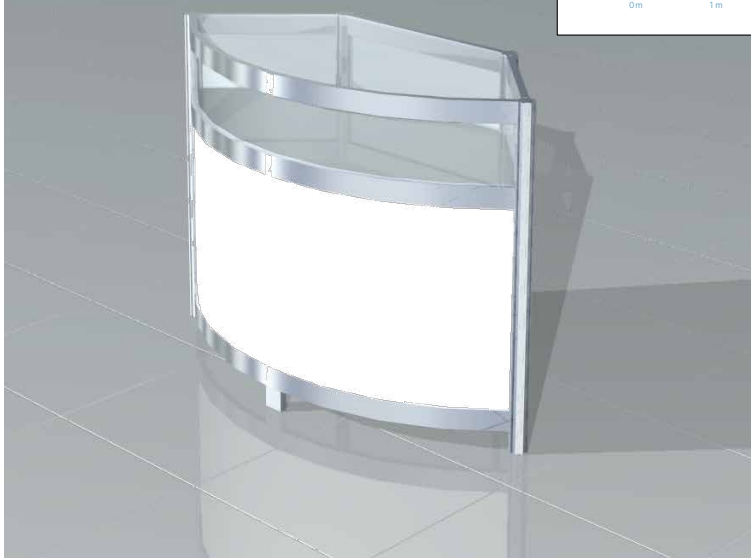
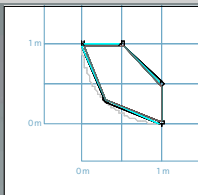

Comptoir 8

Comptoir rond
2x 1mdr x 42''

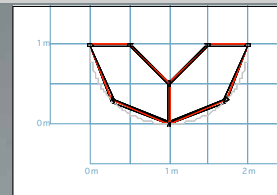

MOBILIER

Comptoir 9

Comptoir
2m x 0,5m x 42''

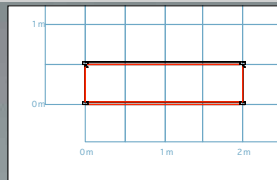

Comptoir 10 - #156

Comptoir
2mdr x 42''

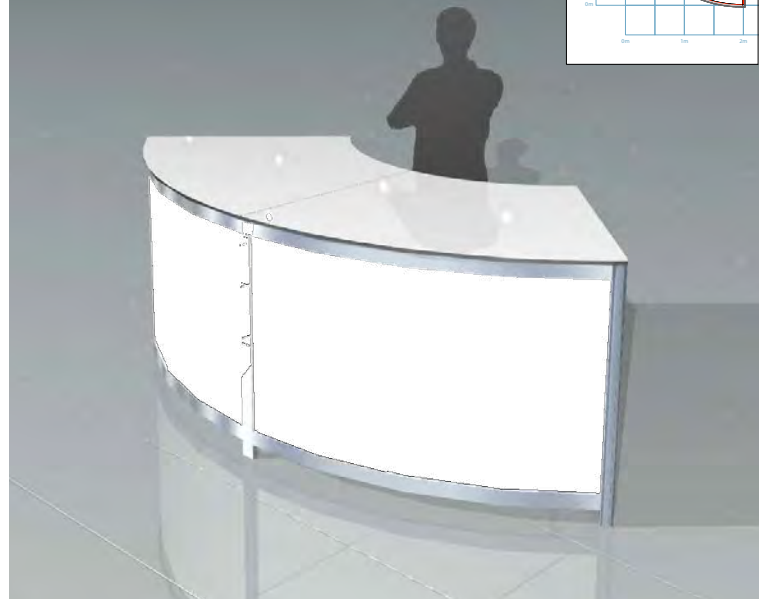
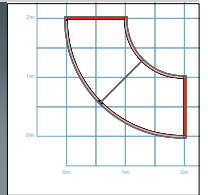

Comptoir 11

Comptoir
2m x 0,5m x 48''

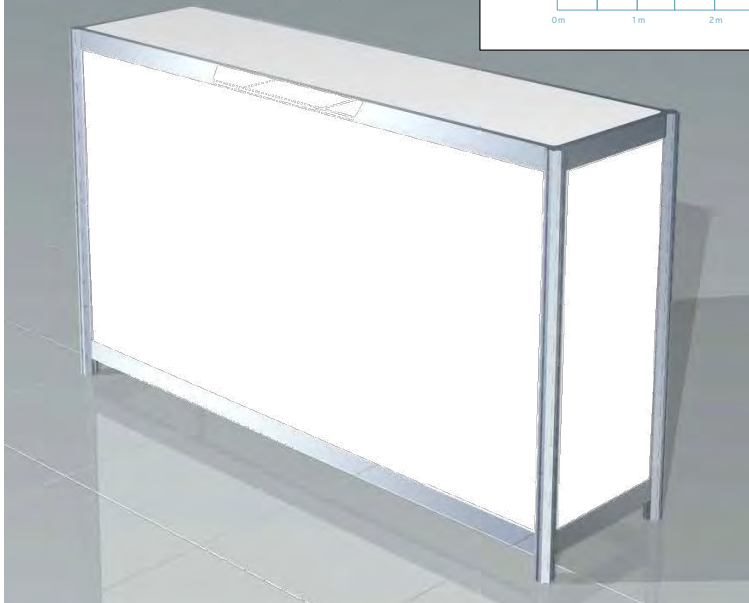
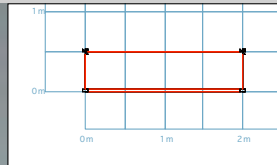

Comptoir 12

Comptoir
2m x 1m x 42''

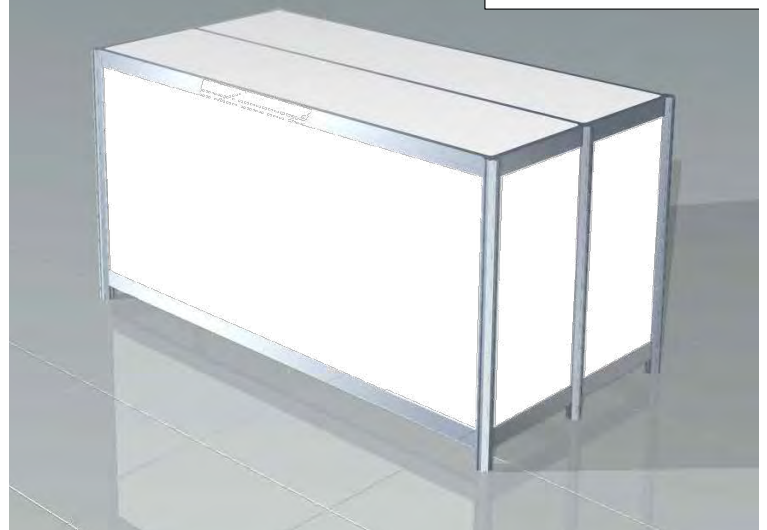
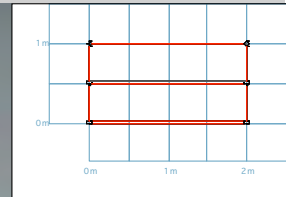

MOBILIER

Comptoir 13

Comptoir information
2m x 0.5md x 42''

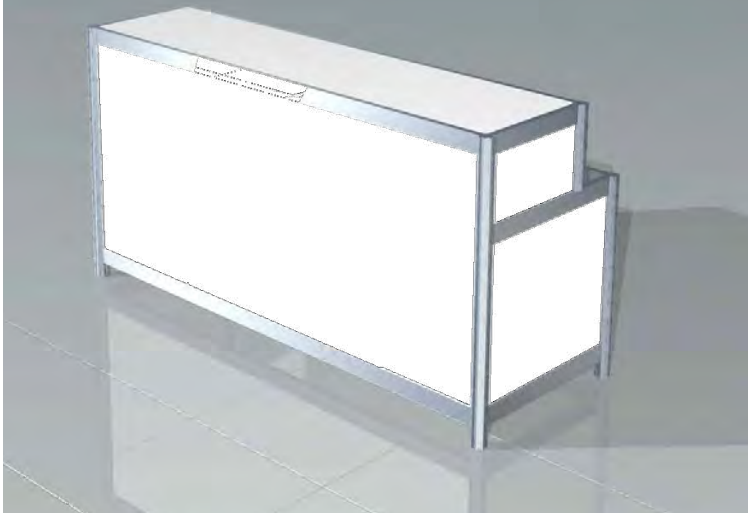
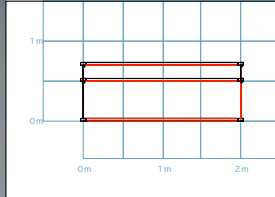

Comptoir 14

Comptoir
2m x 2m x 42''

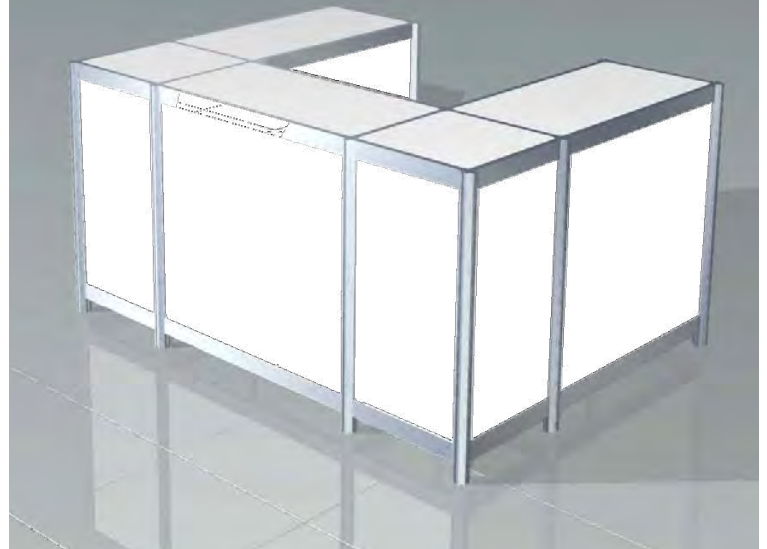
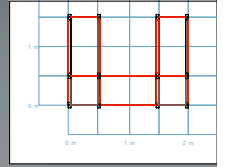

Comptoir 15

Comptoir en coin
3m x 3m x 42''

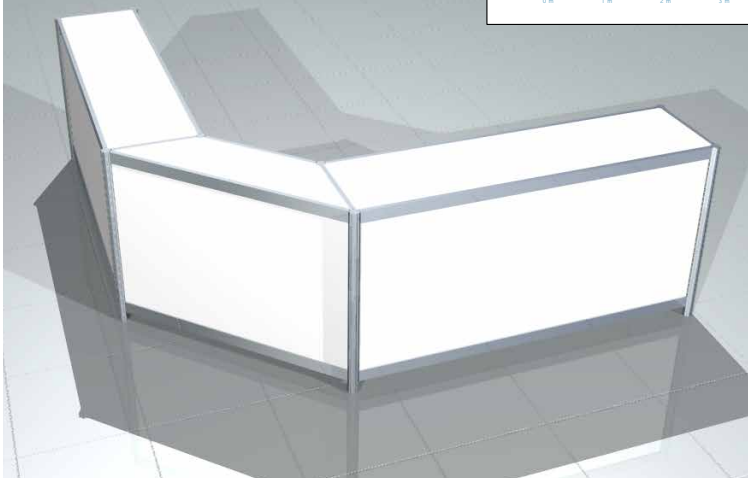
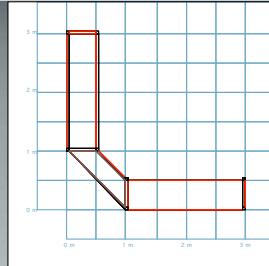

Comptoir 16

Comptoir
2m x 0,5m x 42''

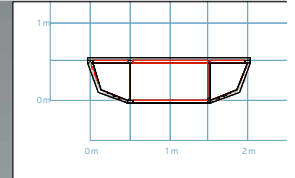

MOBILIER

Comptoir 17

Comptoir en coin arrondi
2m x 2m x 42''

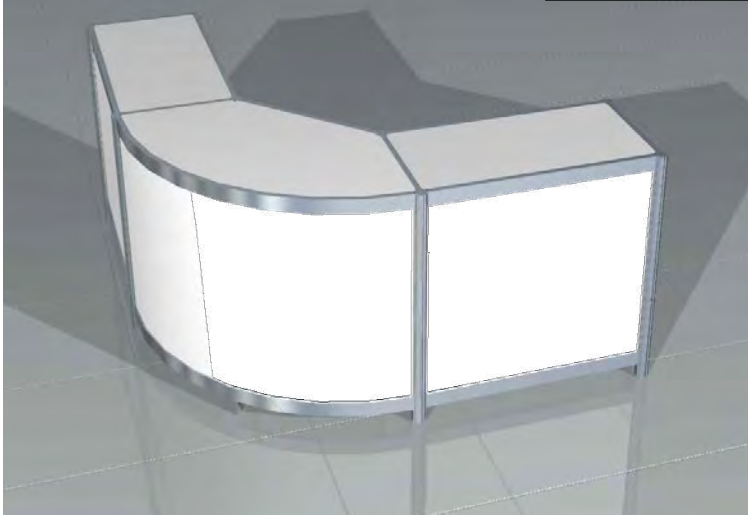
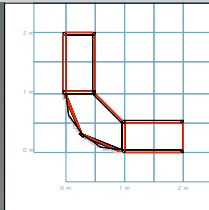

Comptoir 18

Comptoir en U
2m x 1m x 42''

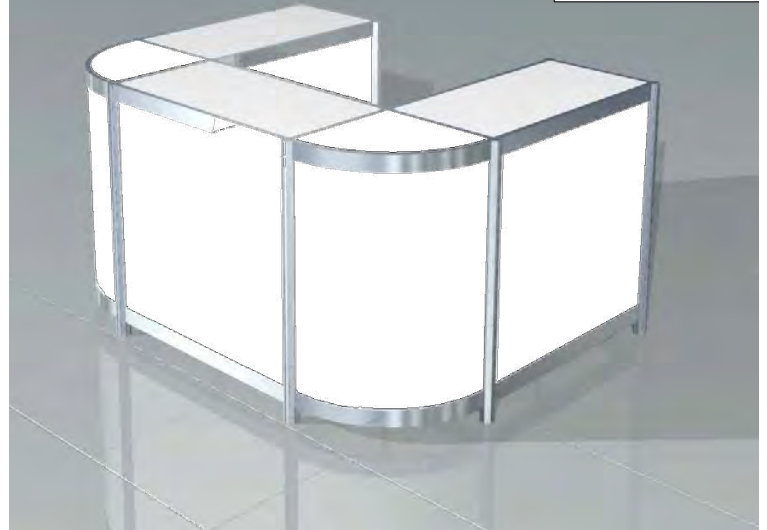
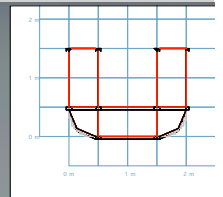

Comptoir 19

Comptoir
3m x 1m x 42''

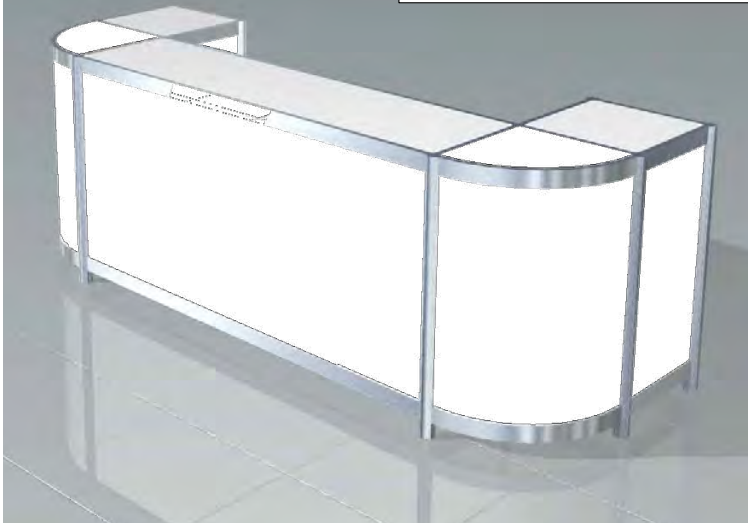
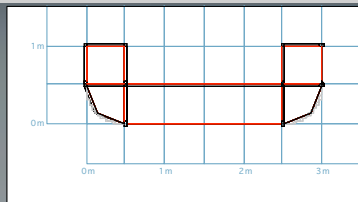

Comptoir 20

Comptoir pour handicapé
3m x 2m x 42''

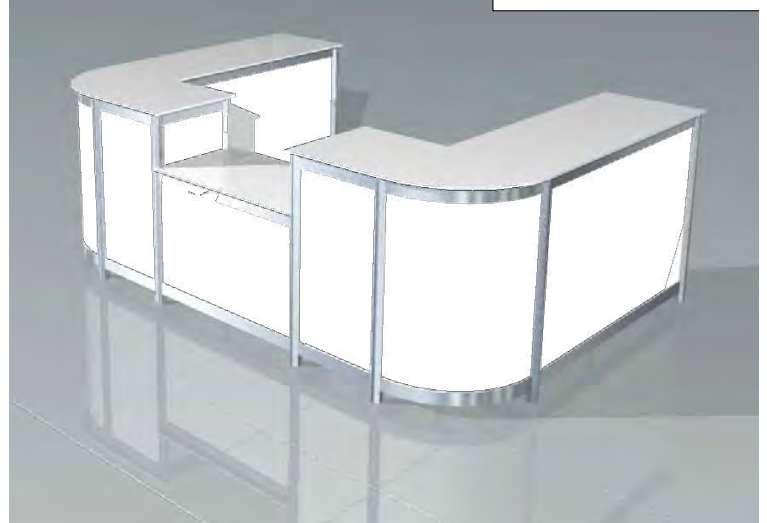
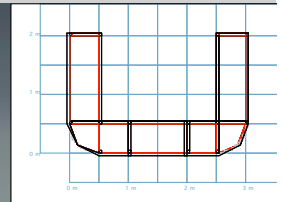

MOBILIER

Comptoir 21

Comptoir de dégustation
avec miroir

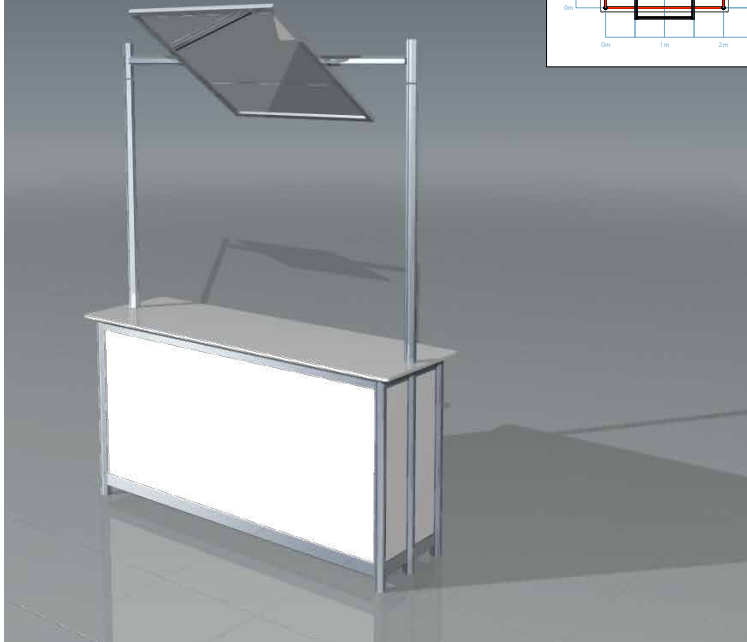
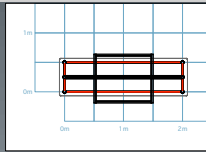

Comptoir 22

Comptoir rayonnage
3m x 3m x 42''

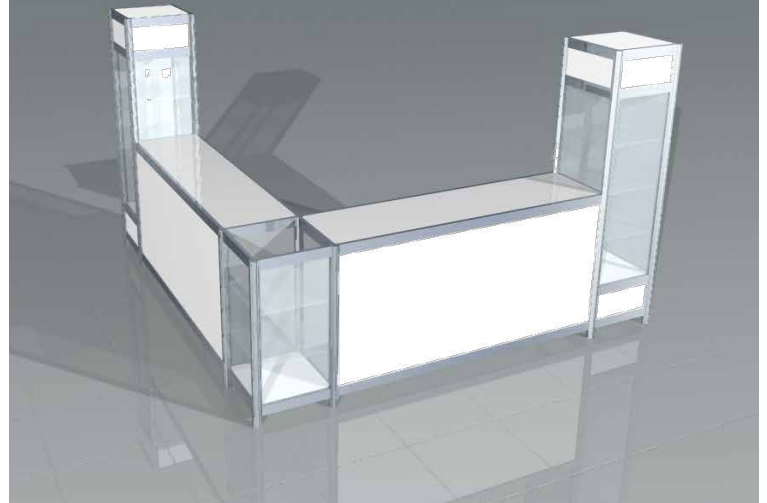

Comptoir 23

Rayonnage
0,5m x 0,5m x 7'

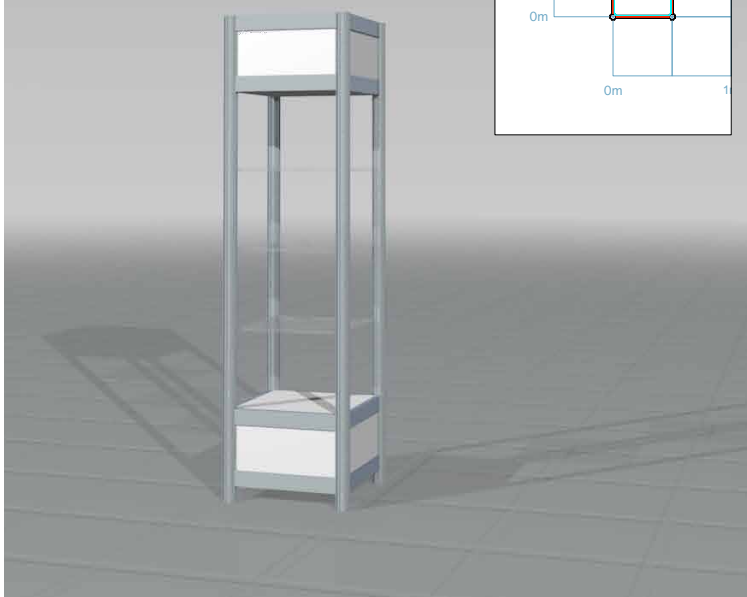
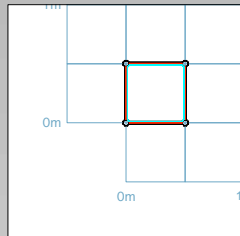

Comptoir 24

Rayonnage
1m x 1m x 7'

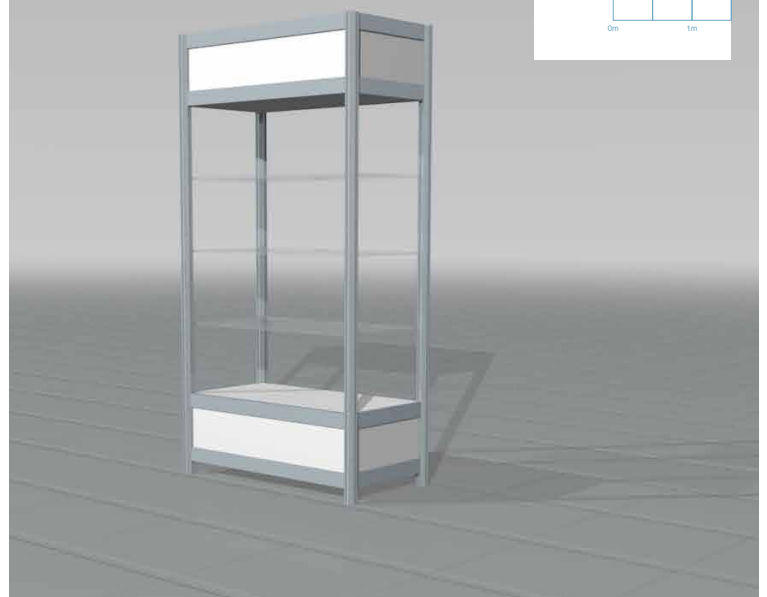
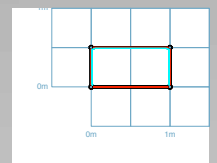

MOBILIER

Comptoir 25

Cloche en plexiglass
0,5mdr x 42''

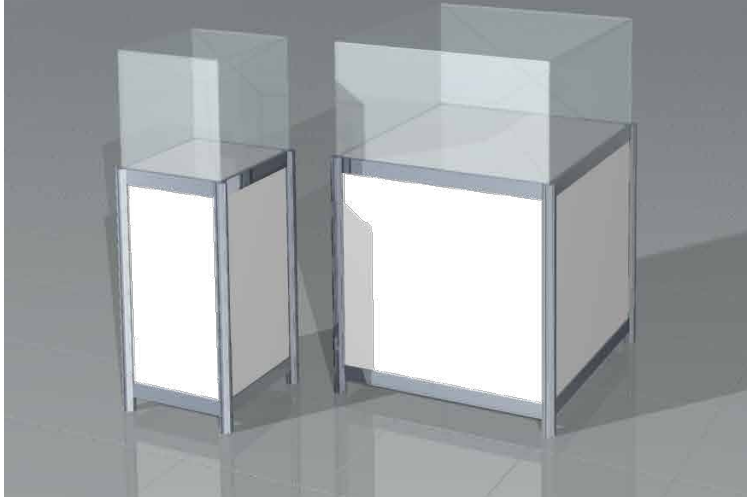
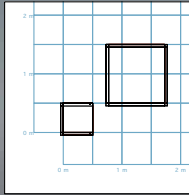

Comptoir 26

Comptoir bureau
1,4m x 2,5m x 42''

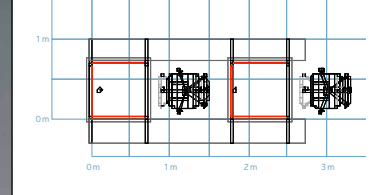

Comptoir 27

Comptoir
3m x 0,5m x 42''

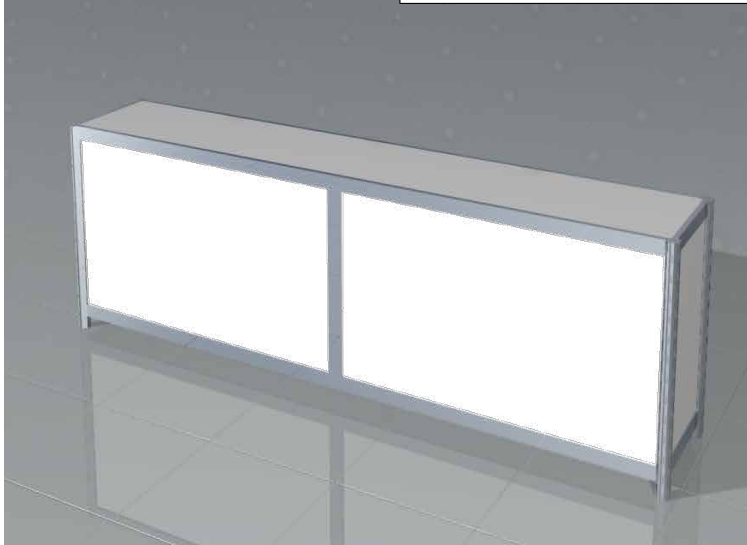
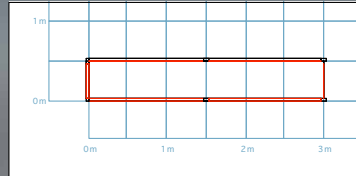

Comptoir 28

Comptoir secrétaire
avec tablette pour clavier d'ordinateur
1,5m x 2m x 30''

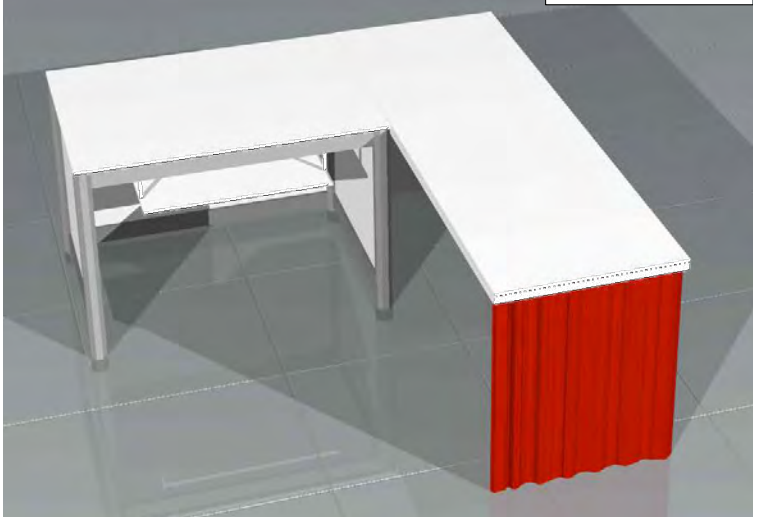
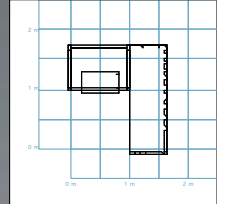

MOBILIER

Comptoir 29

Table d'appoint
0,5m x 0,5m x 30"

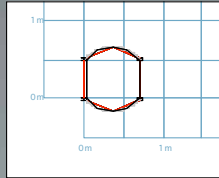

Comptoir 30

Comptoir d'appoint
0,5m x 0,5m x 42"

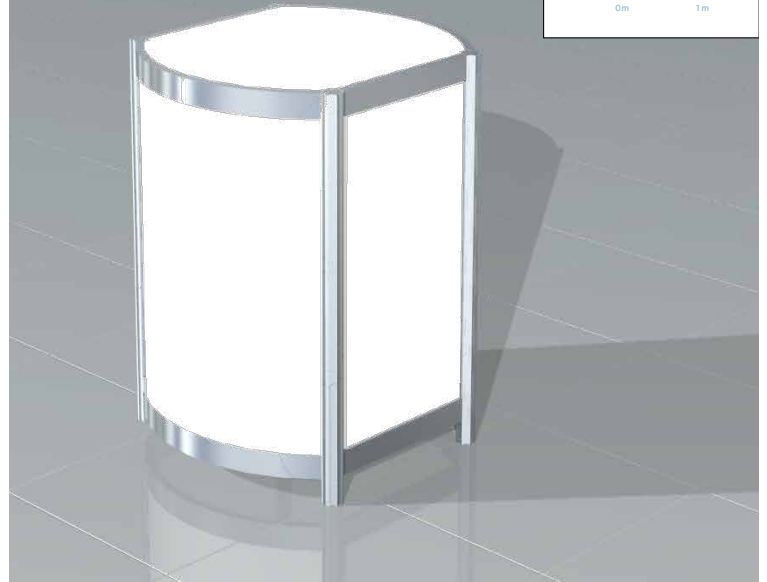
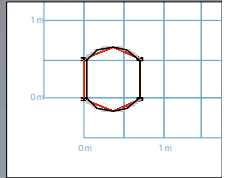

Comptoir 31

Table haute
1m x 0,5m x 42"

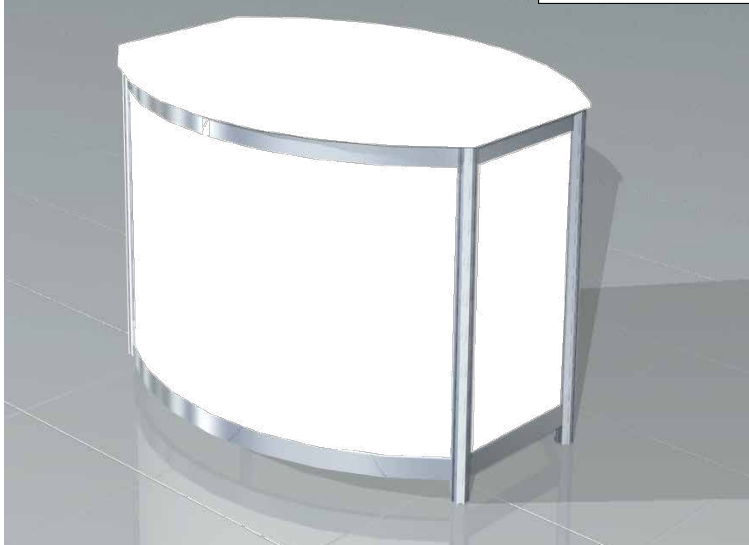
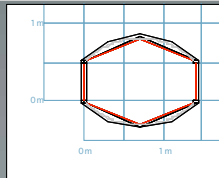

Comptoir 32

Comptoir d'accueil
1m x 0,5m x 42"

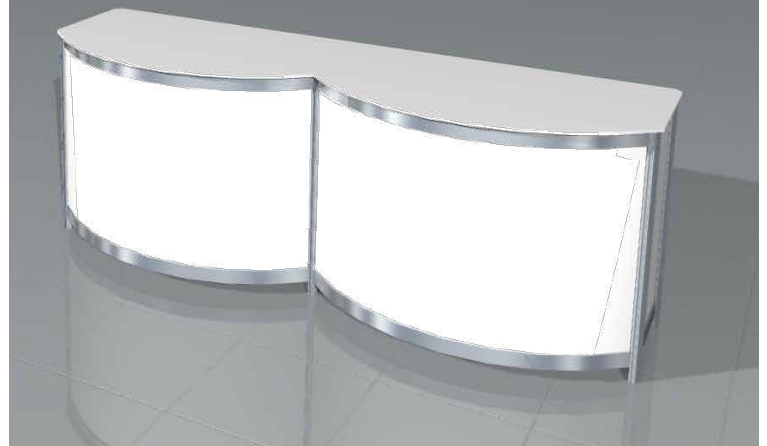
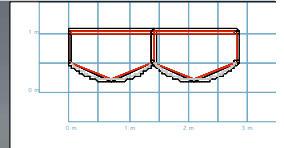

MOBILIER

Comptoir 33

Table de conférence
0.5mdr x 42''

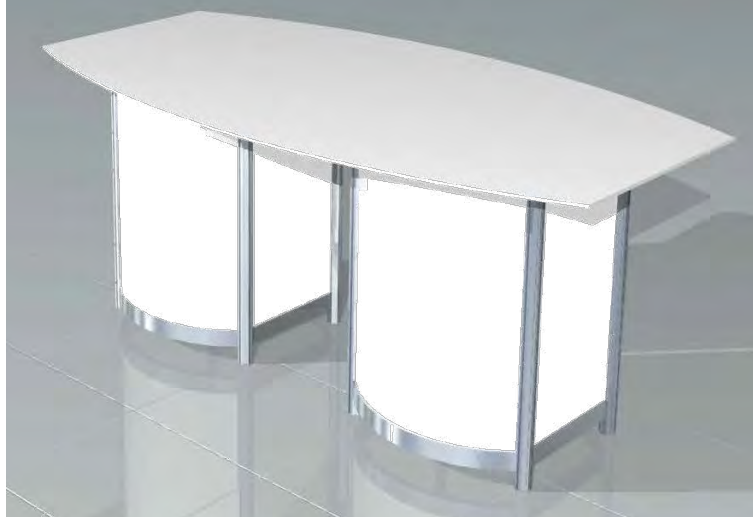
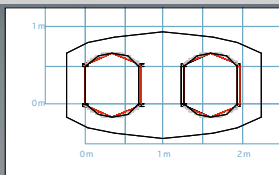

Comptoir 34

Table de conférence
2mdr x 42''

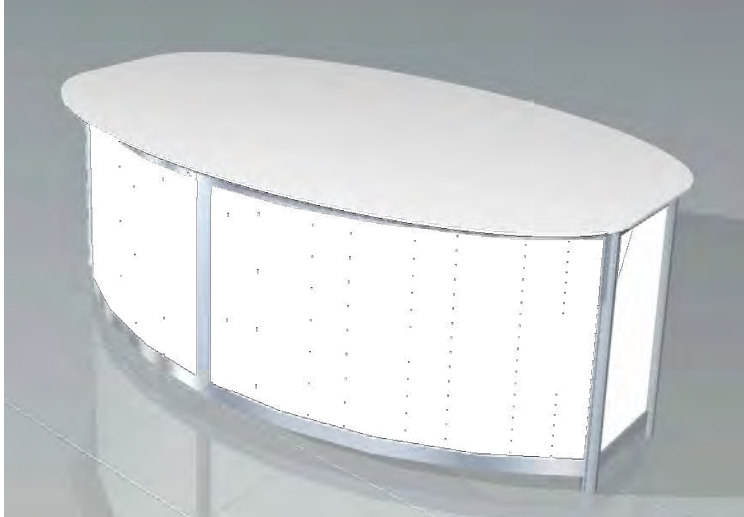
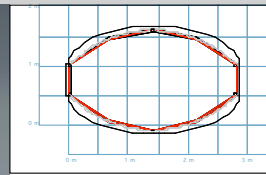

Comptoir 35

Comptoir rond
1m x 1m x 42''

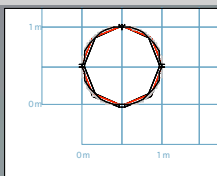

Comptoir 36

Comptoir information
1mdr x 42'' avec fascia à 8'

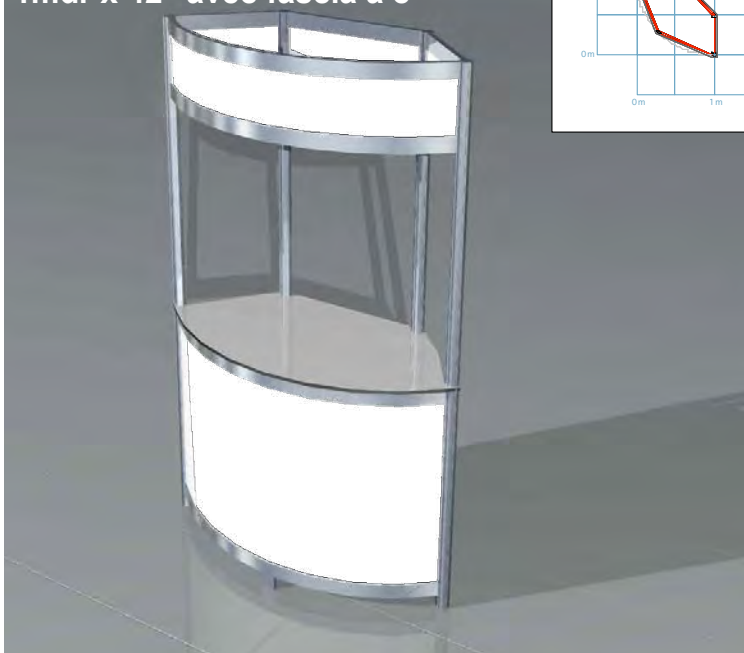
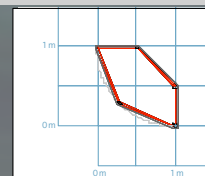

MOBILIER

Comptoir 37

Comptoir accueil
1mdr x 42'' avec fascia à 8'

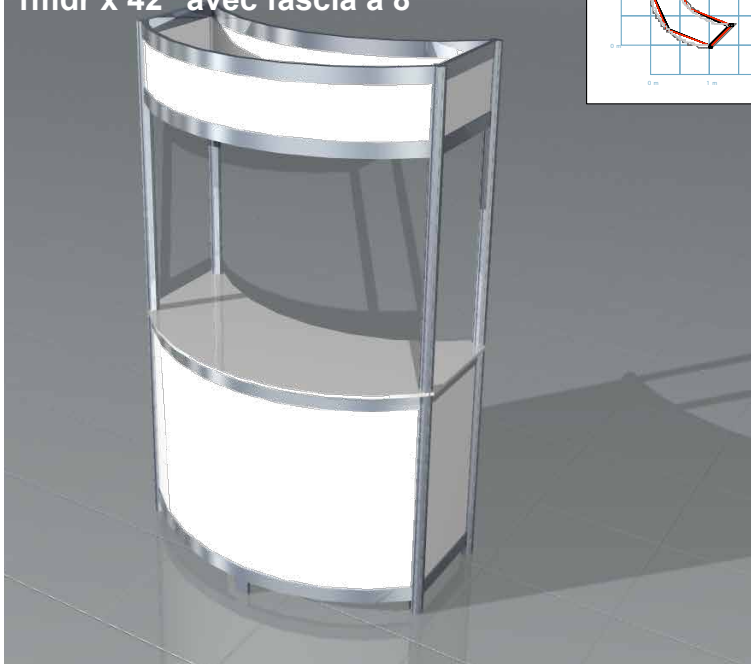
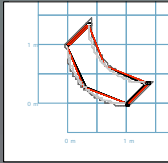

Comptoir 38

Comptoir accueil
2x 1mdr x 42'' avec fascia à 8'

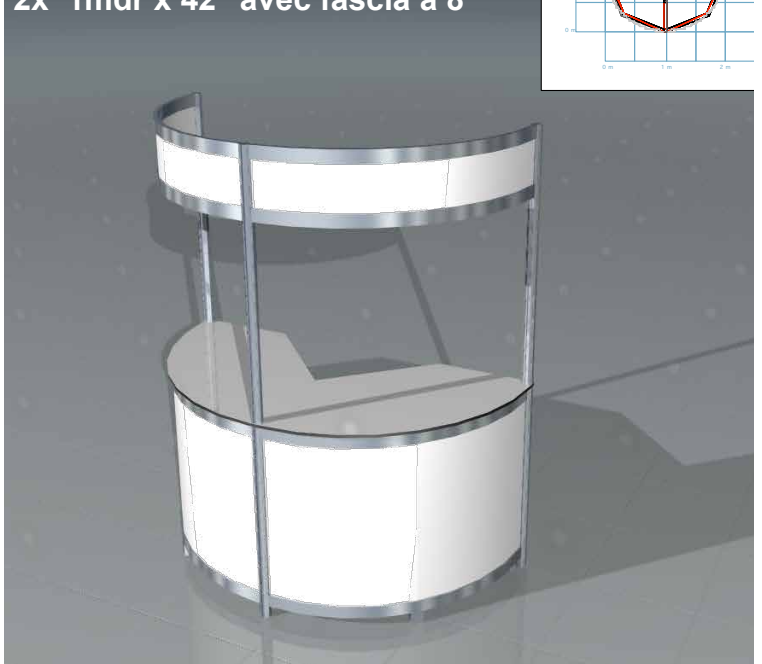
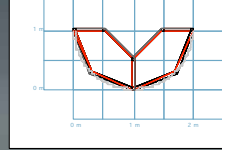

Comptoir 39

Comptoir information
3x 1mdr x 42'' avec fascia 30''

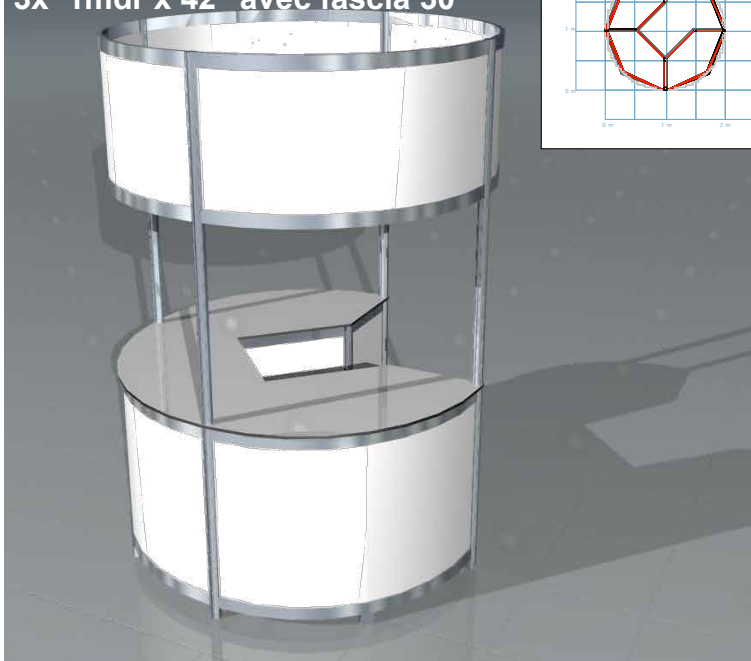
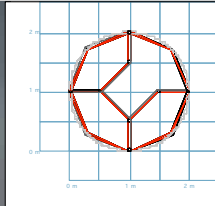

Comptoir 40

Comptoir inscription standard
2m x 42'' avec fascia a 8'

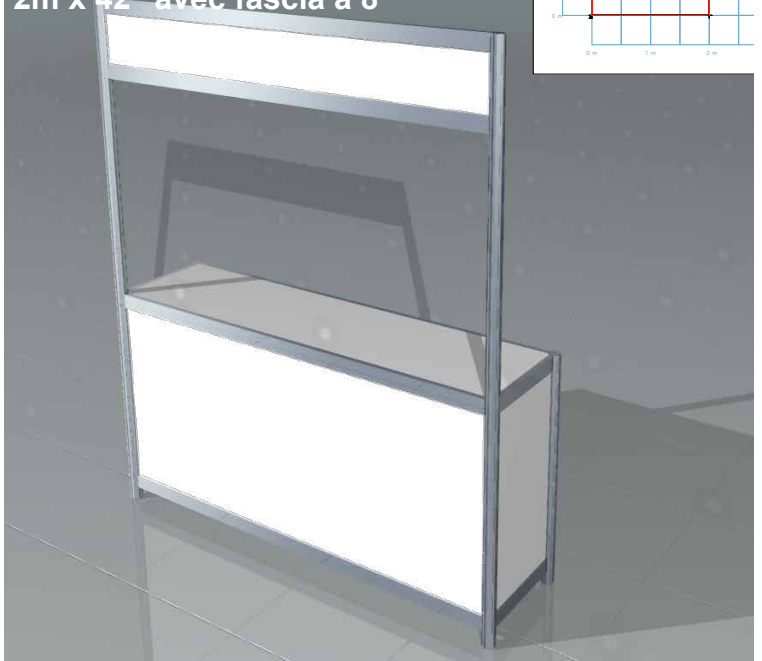
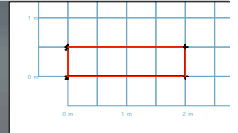

MOBILIER

Comptoir 41 - #170

Comptoirs
Flash

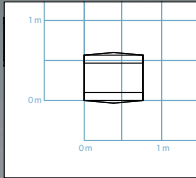

Comptoir 42 - #170

Comptoir
Flash dessus arrondi

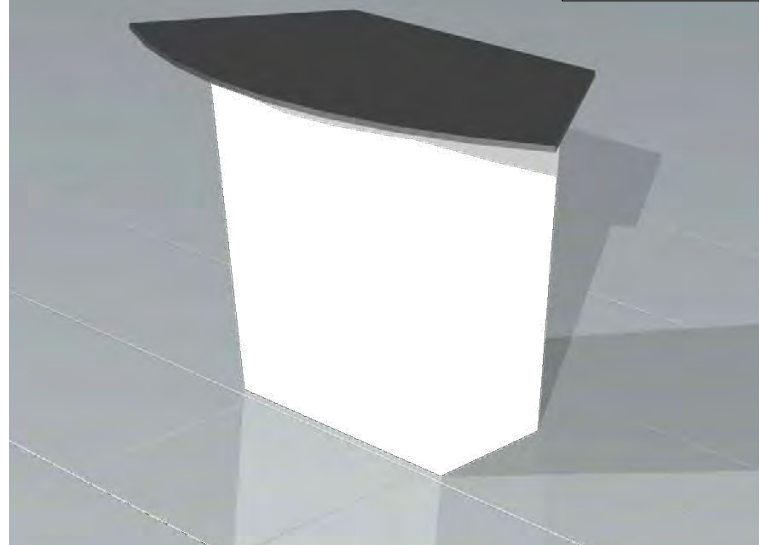
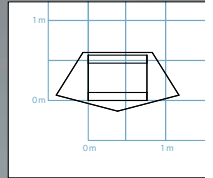

Comptoir 43 - #172 - #171

Stèles Flash
et Stèle Flash internet



Comptoir 44

Stèles Flash
double et triple

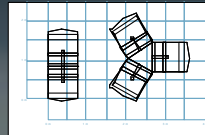

MOBILIER

Comptoir 45

Comptoir click
1mdr X 1m

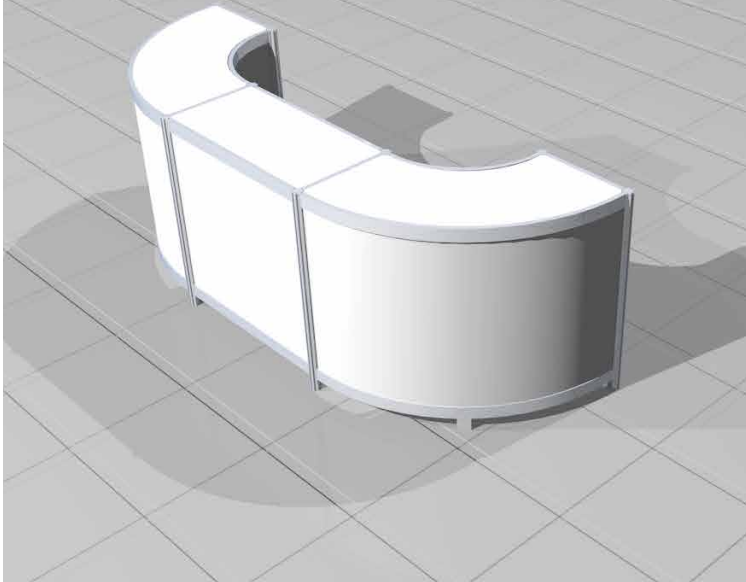
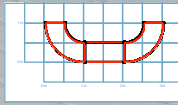

Comptoir 46

Comptoir bar
2m X 0,5md

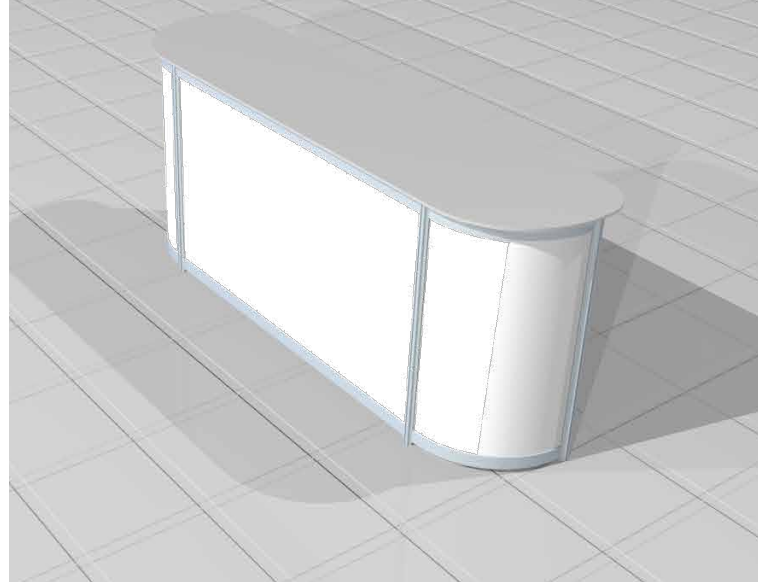
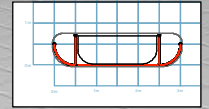

Comptoir 47

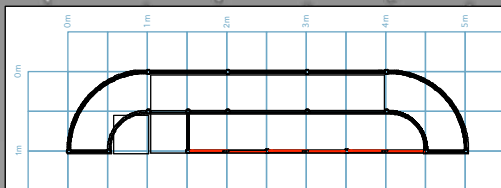

Comptoir 48

Comptoir Rayonnage

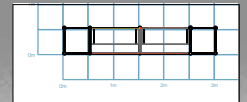

MOBILIER

Comptoir 49

Comptoir Rideau
2m X 1m X 36''

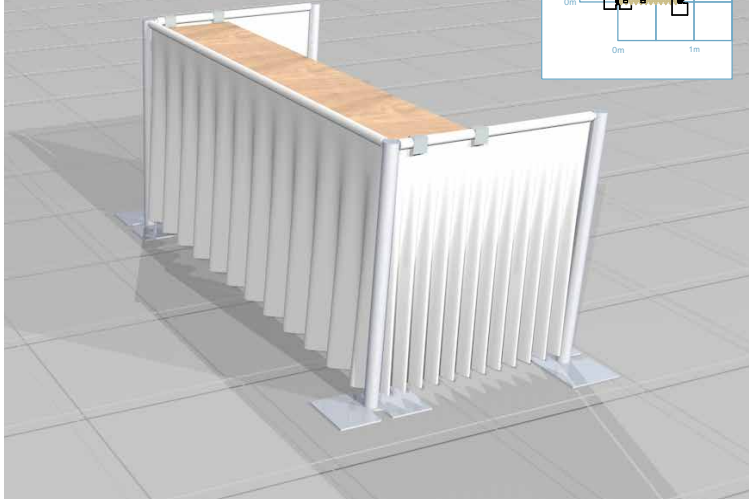
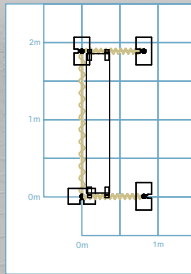

Comptoir 50

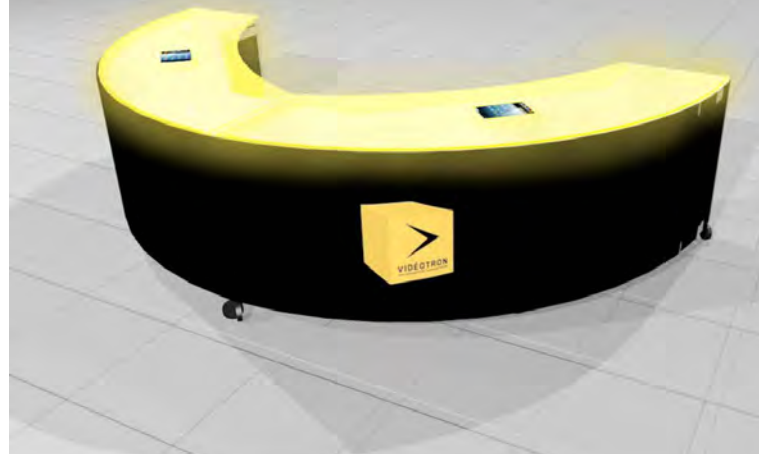
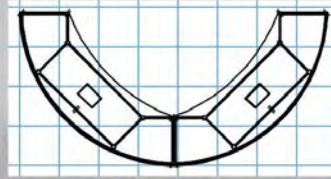

Comptoir 51

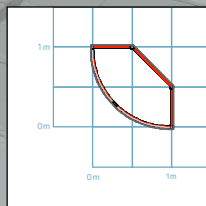

Comptoir 52

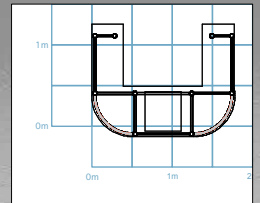

MOBILIER

Comptoir 53

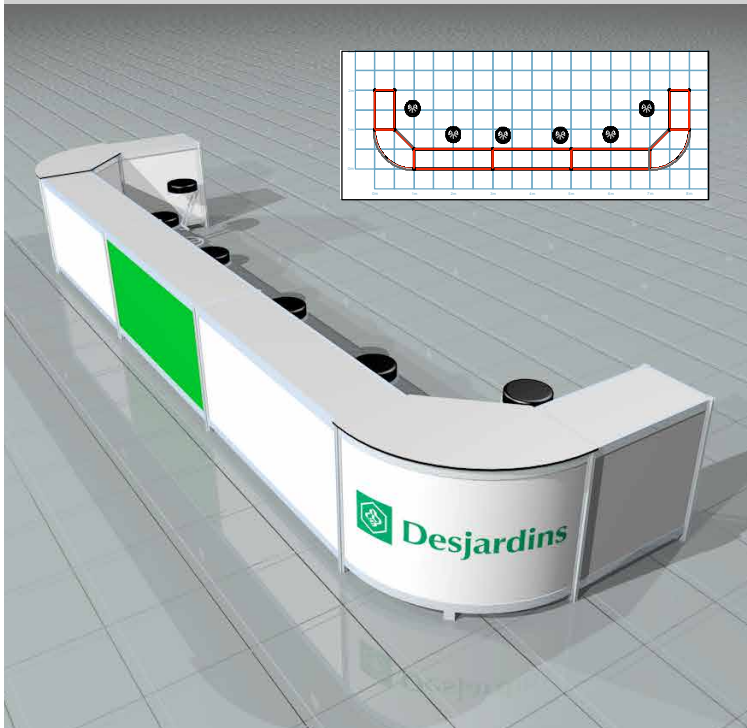

Comptoir 54 - Présentoir de musée

1m x 0,5m & 1m x 0,5md

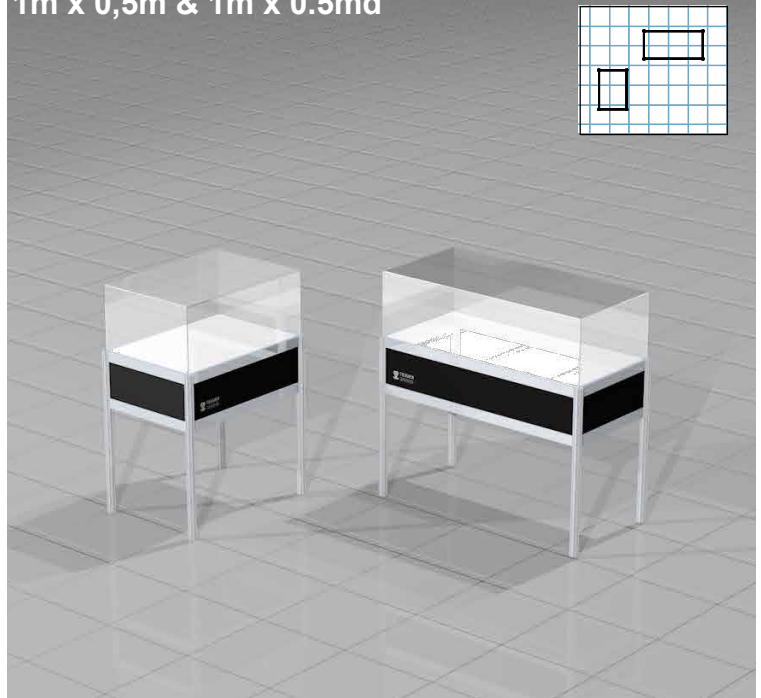

Comptoir 55 - Présentoir à publications

1m x 5' de haut

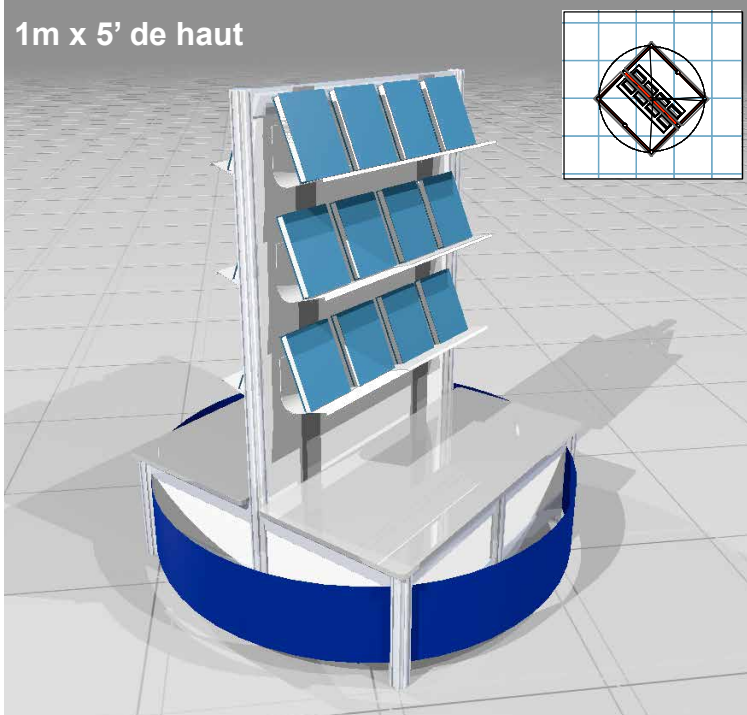

Comptoir 56 - Pupitre

0,5md x 0,5m

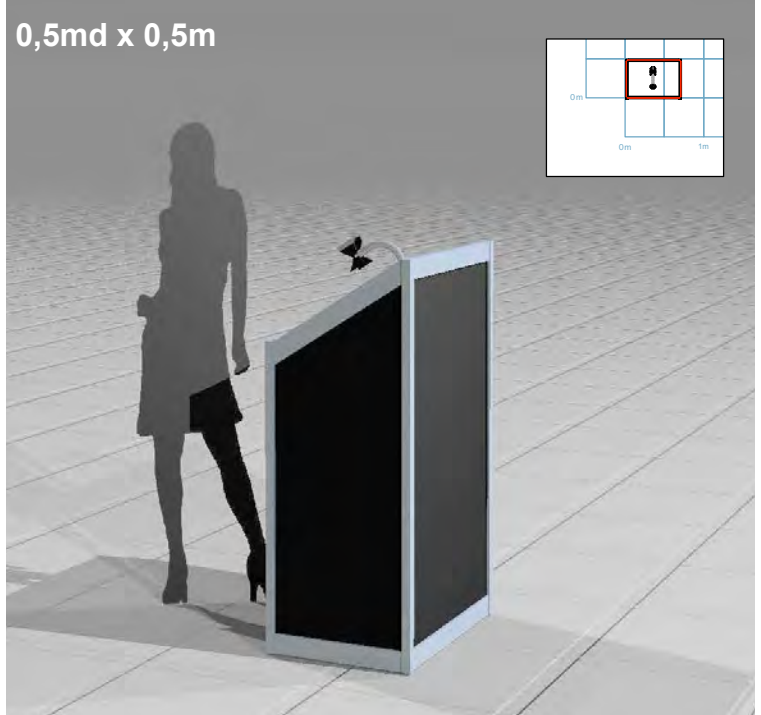

MOBILIER

Comptoir 57

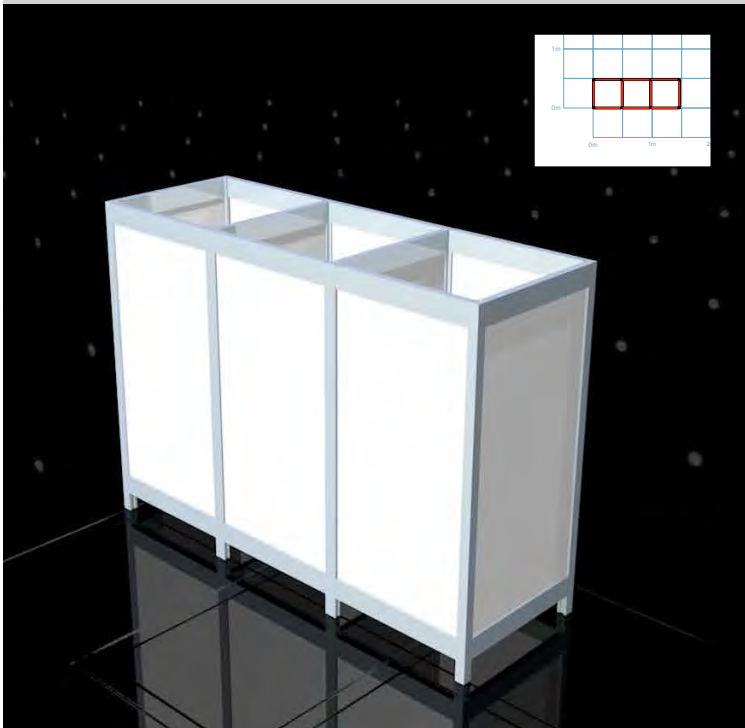

Comptoir 58

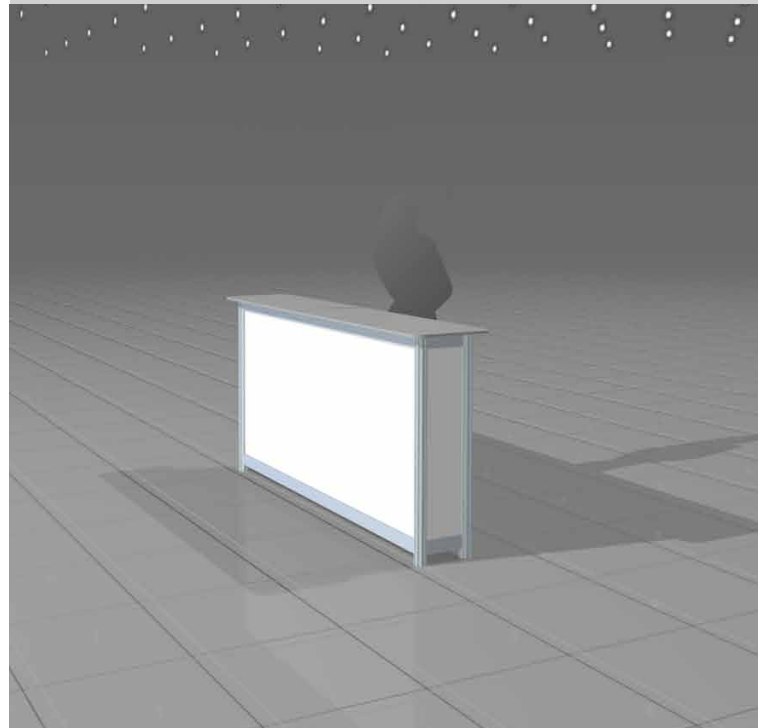

Comptoir 59

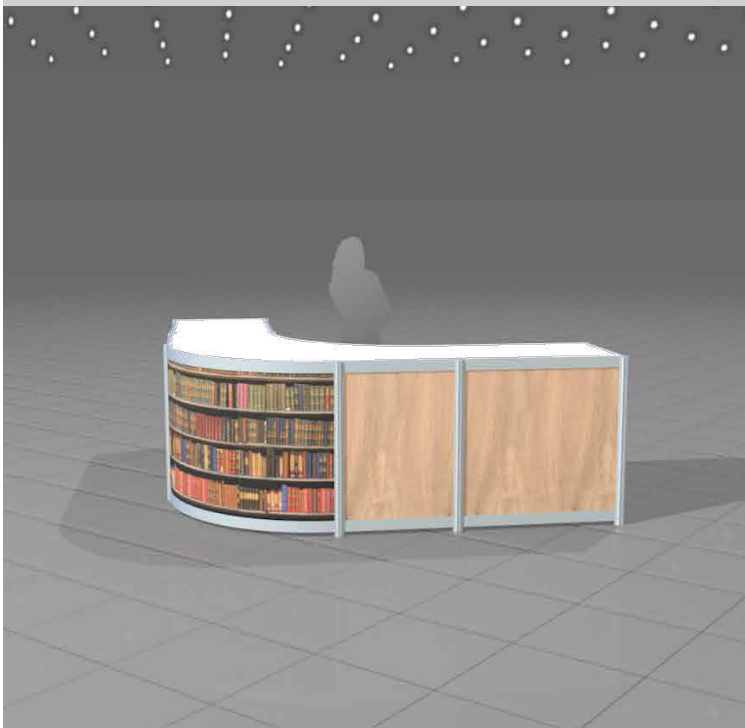

Comptoir 60 - Porte-documents

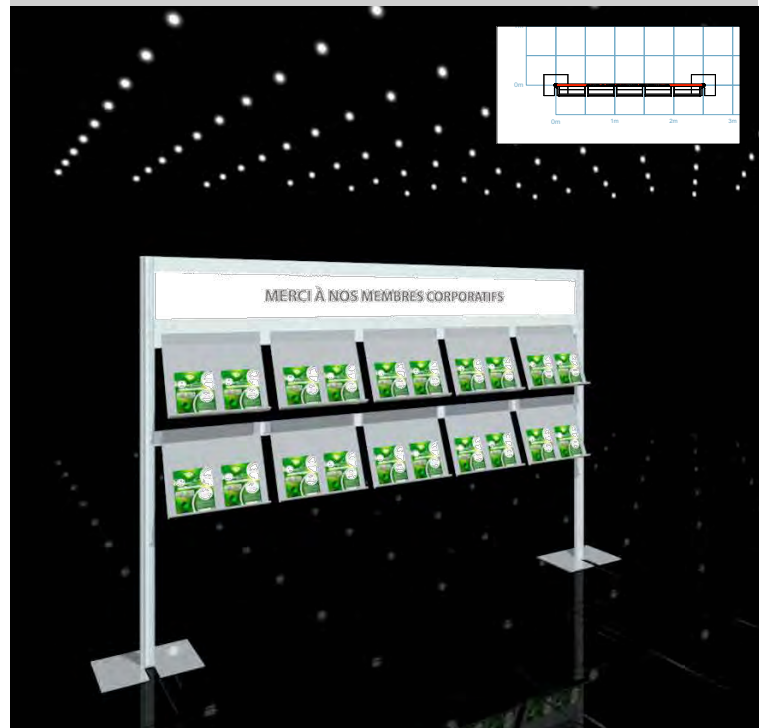

MOBILIER

Comptoir 61

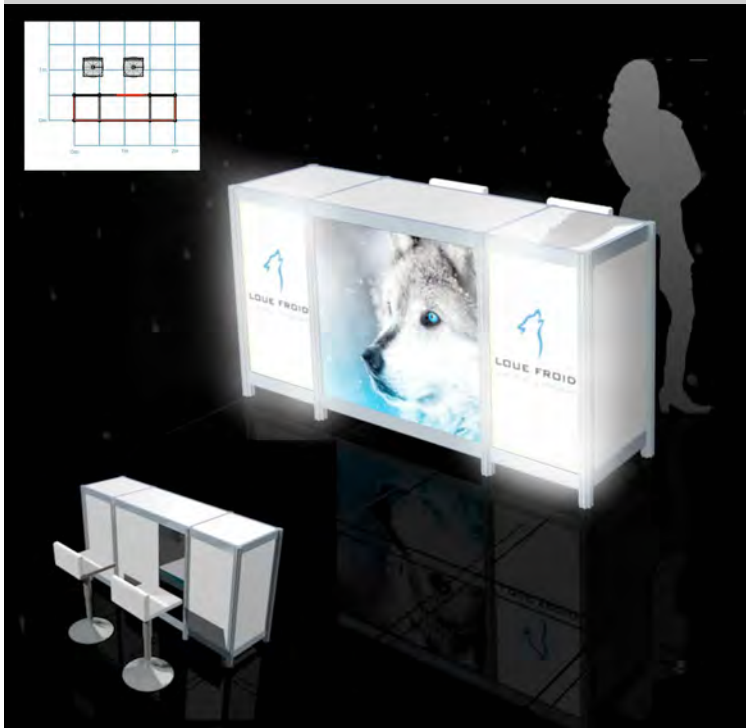

Comptoir 62

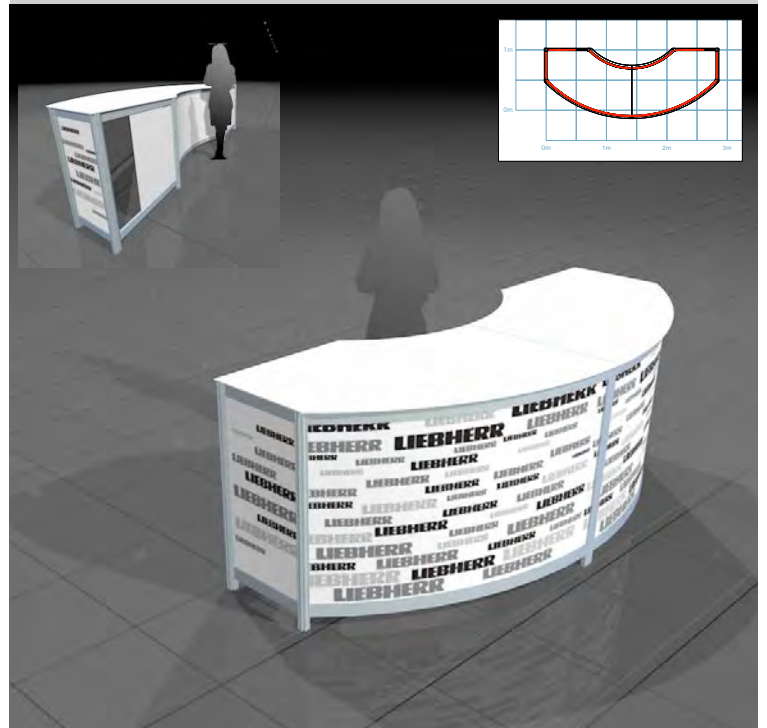

Comptoir 63

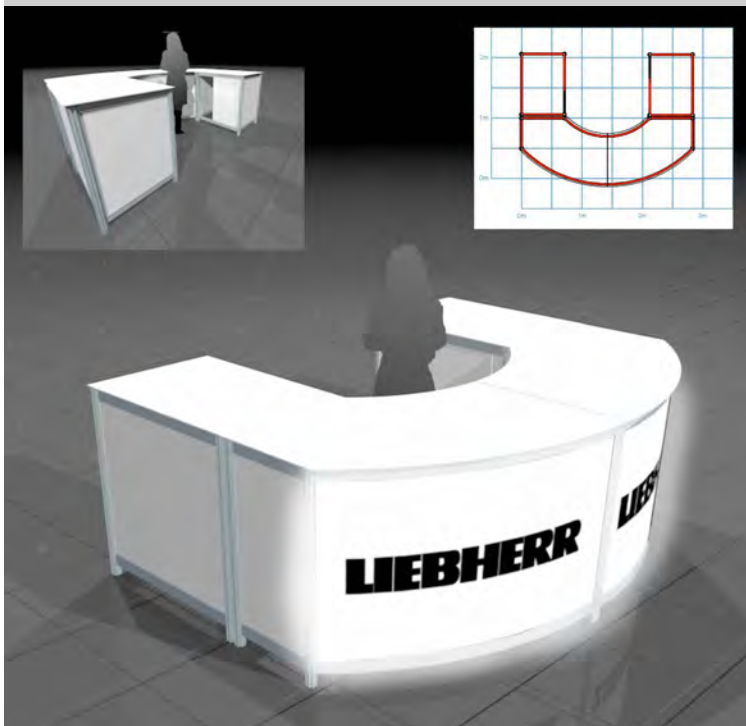

Comptoir 64



MOBILIER

Comptoir 65

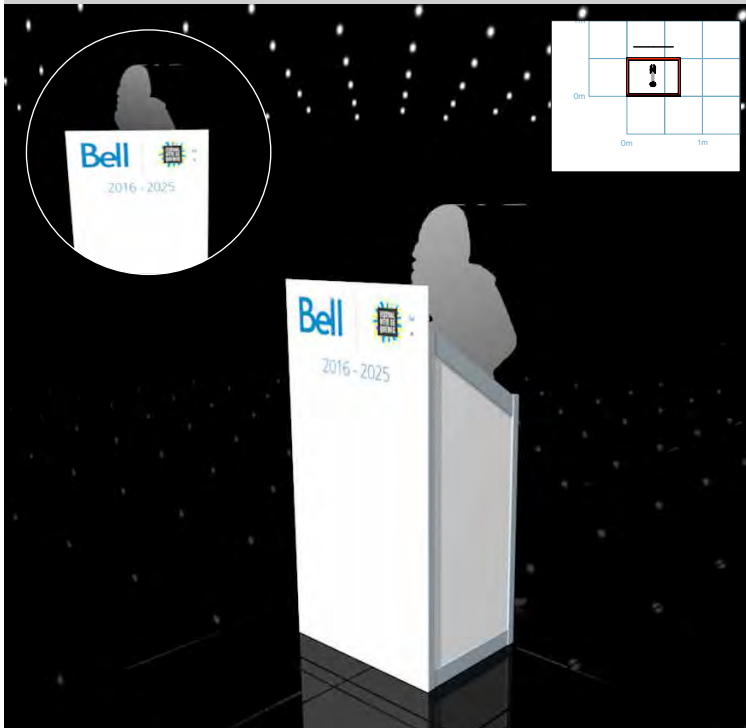

Comptoir 66

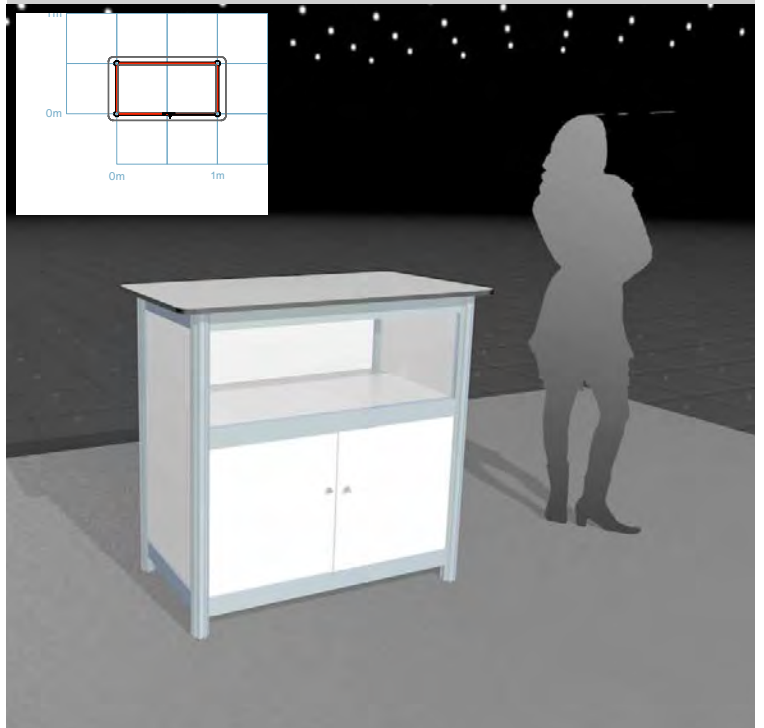

Comptoir 67

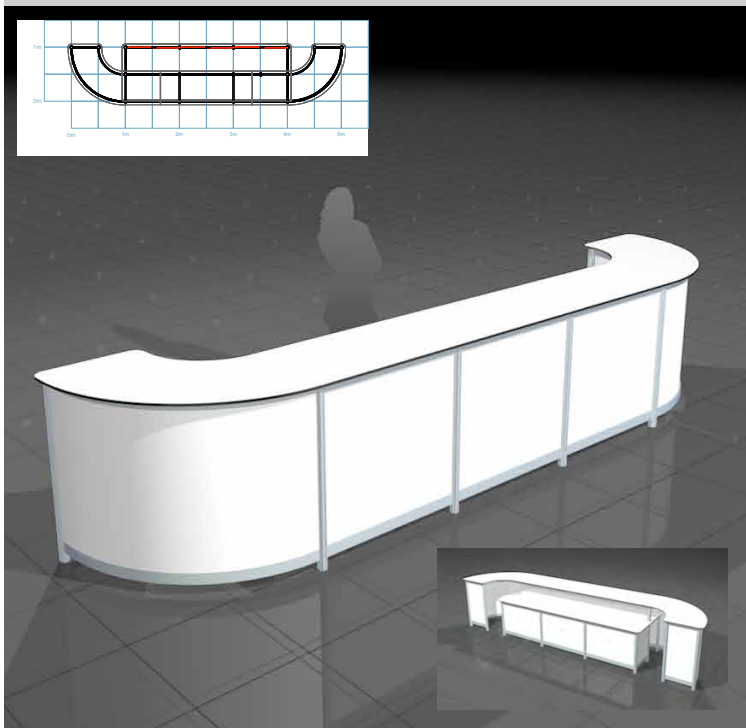

Comptoir 68

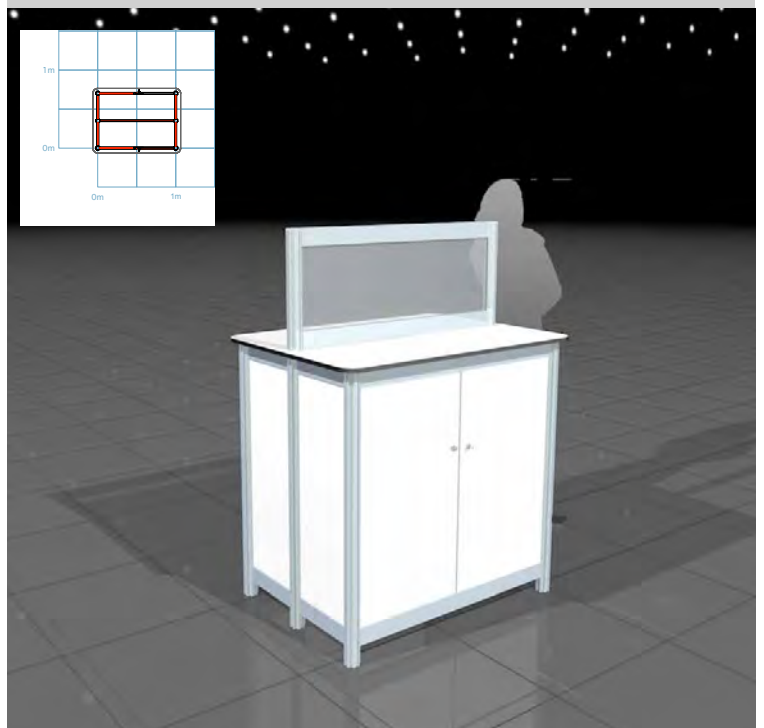

MOBILIER

Comptoir 69

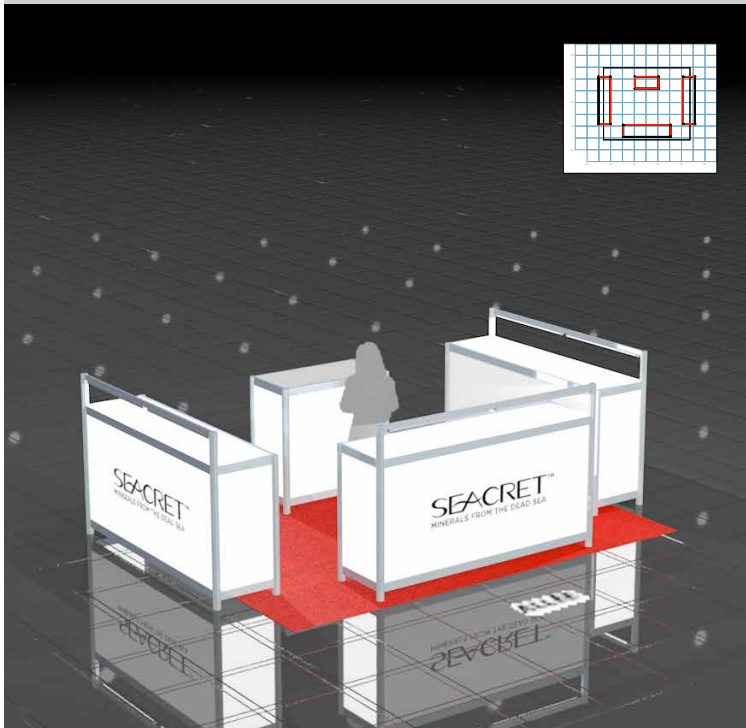

Comptoir 70

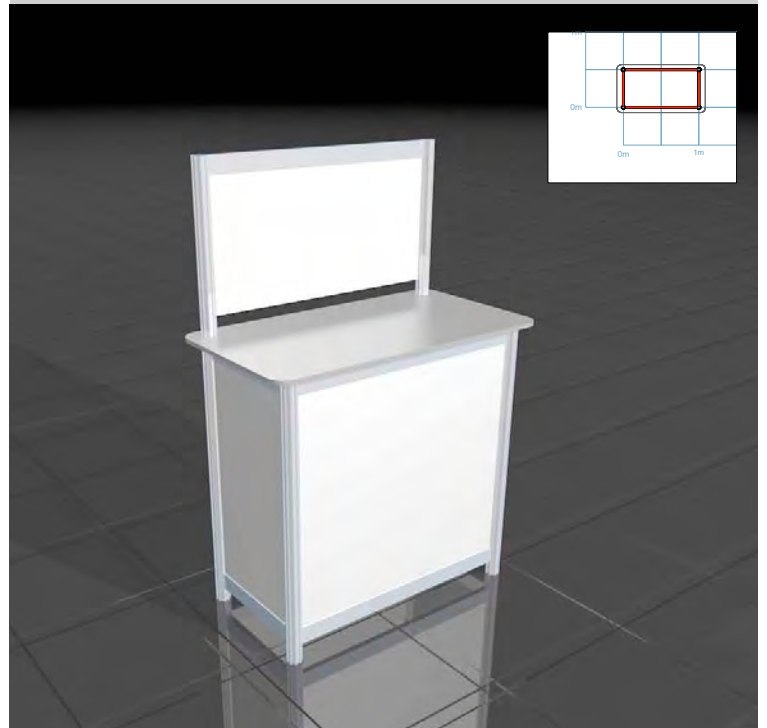

Comptoir 71

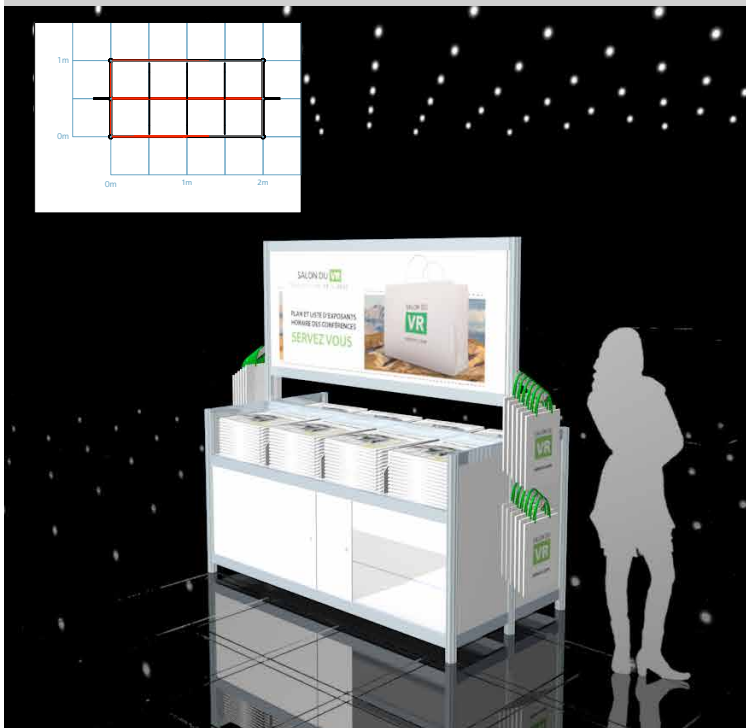

Comptoir 72

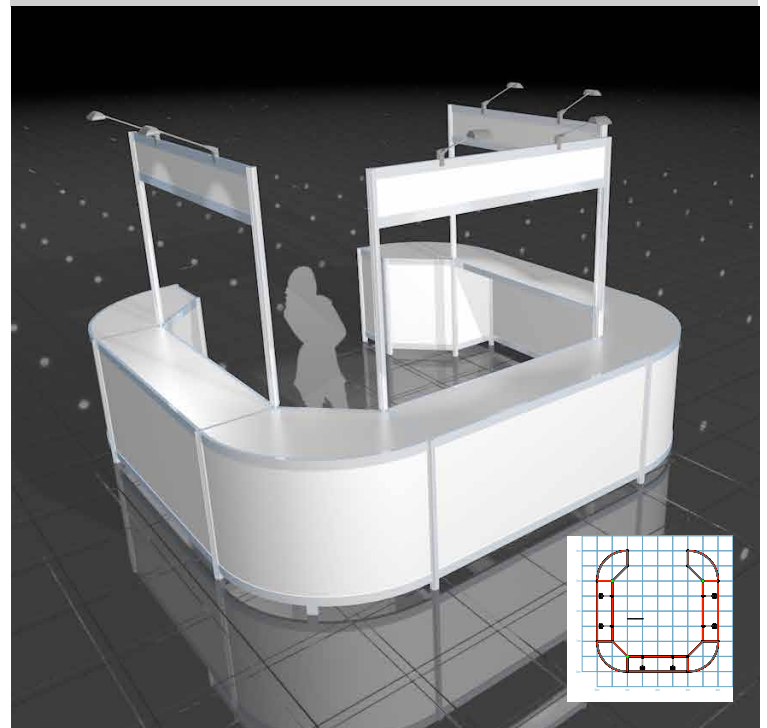

MOBILIER

Comptoir 73

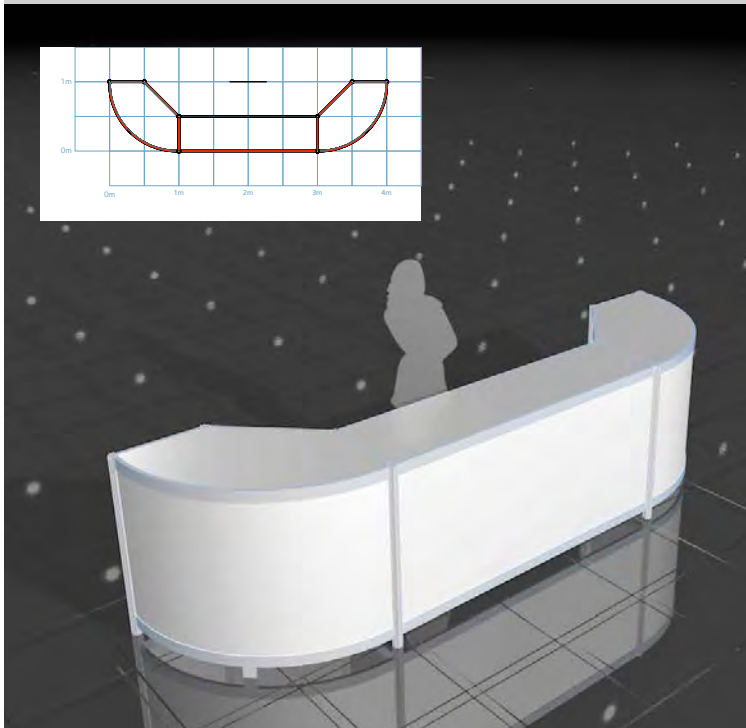

Comptoir 74

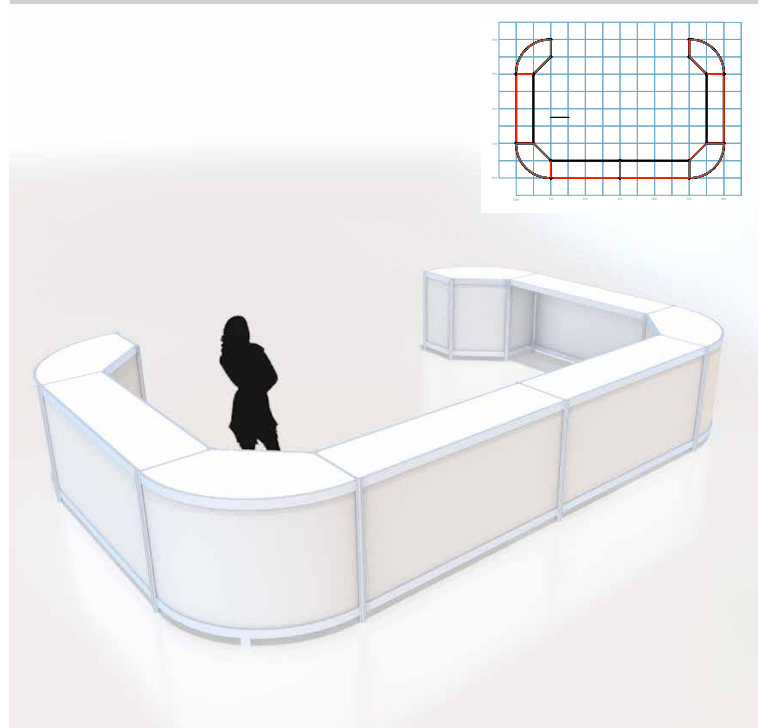

Comptoir 75

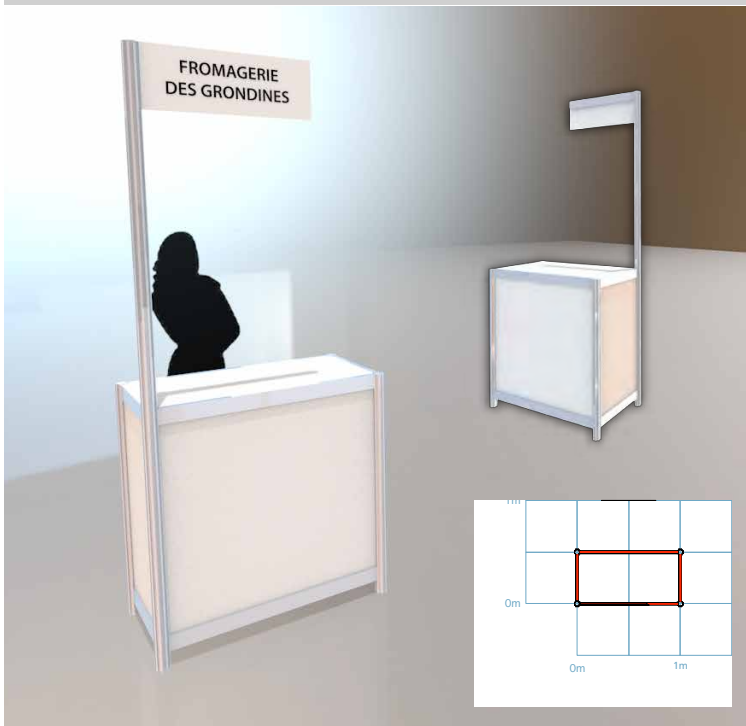

Comptoir 76



MOBILIER

Comptoir 77

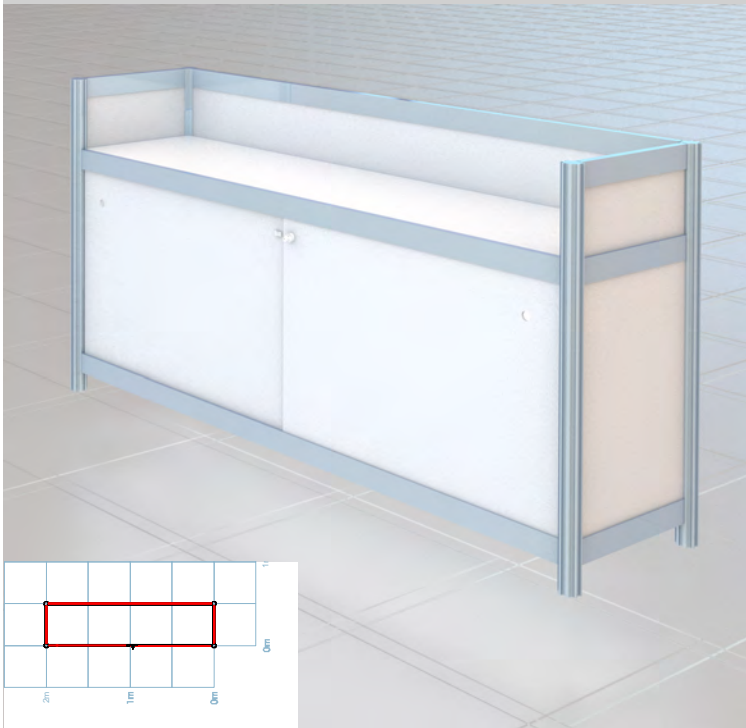

Comptoir 78

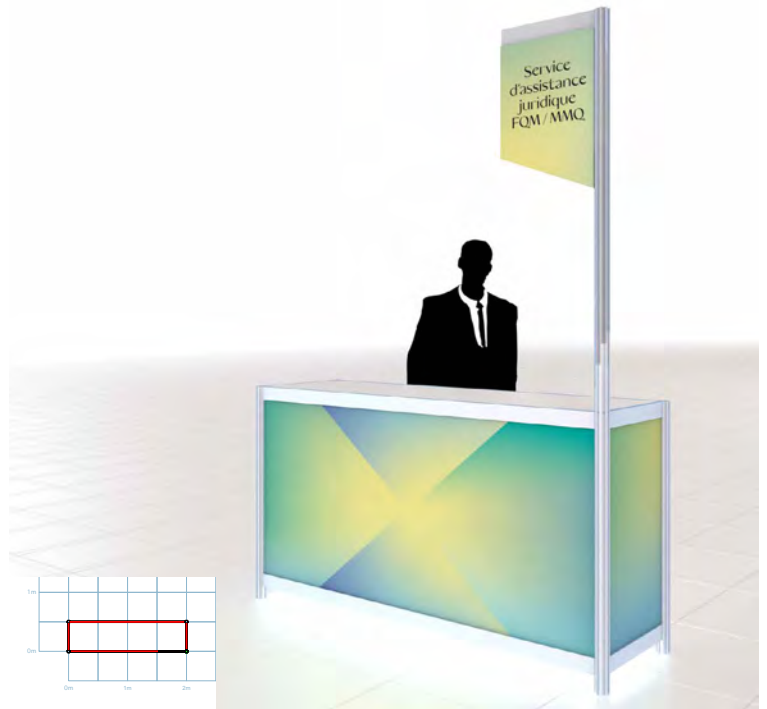

Comptoir 79



Comptoir 80

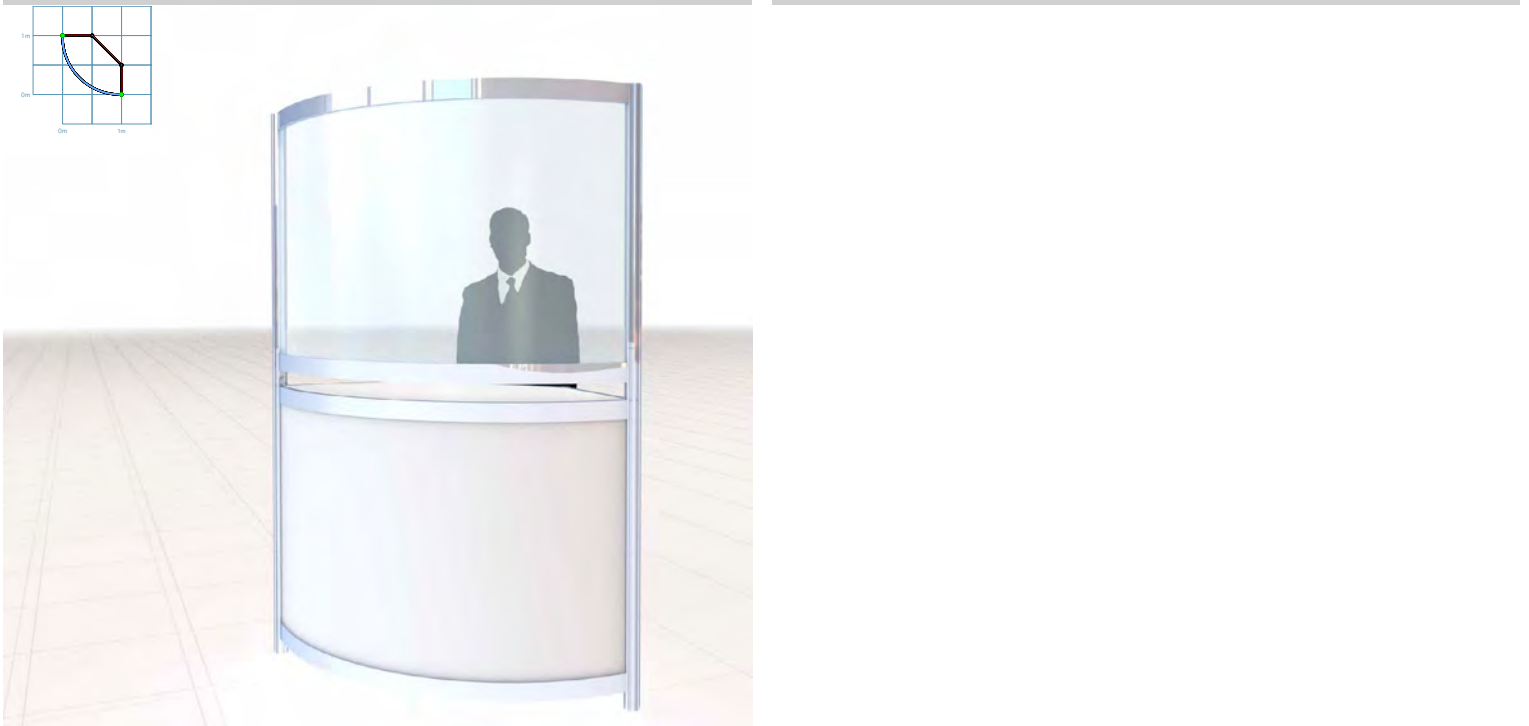

MOBILIER

TABLETTES

TABLETTES VERSATILES



LARGEUR 16.5" OU 33"
6" DE PROFOND

VUE DE
PROFILE

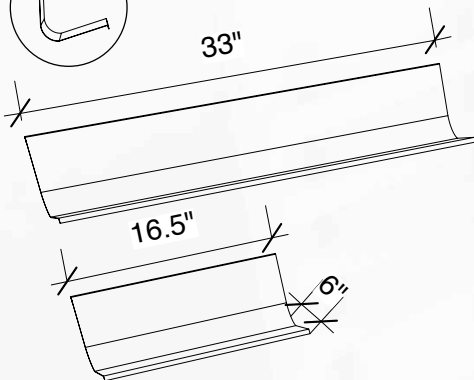
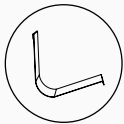

TABLETTES SLOTWALL



LARGEUR 1/2 M OU 1M
12" DE PROFOND

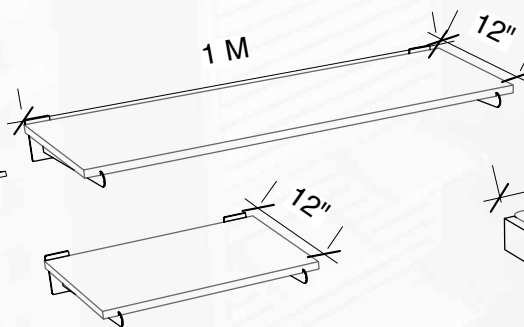

TABLETTES CLICK



LARGEUR 1M
12" DE PROFOND
SUPPORTE JUSQU'À 100LBS

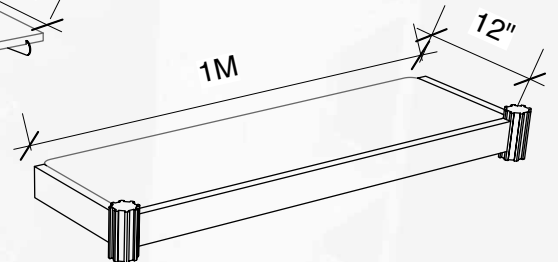

MOBILIER

Rayonnages et supports

Spécifications

1. Présentoir 0,5m x 8' avec des crochets cascade pour accrocher des vêtements.
2. Rayonnage 0,5m x 0,5m, 0,5m x 1m & 1m x 1m - #154
3. Supports à vêtement
4. Grillage servant à l'accrochage
5. Tablette et Crochets pour slotwall
6. Tablettes Click à 90° - #160
7. Crochet mur velcro
8. Rail vestimentaire / Barre d'accrochage de 2' de large & support à vêtement dos-à-dos
9. Tablettes à littérature



Cascade pour CLICK



5f

Crochet mur velcro



7

Support à chapeau pour slotwall



5b

Crochet pour slotwall 4", 8"



5d

Tablette en plexiglas 15"p X 12" L



5g

Rail vestimentaire / Barre d'accrochage de 2' de large

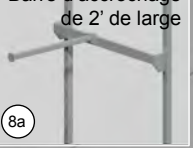

8a

Support à tablettes pour slotwall 10", 12", 14"

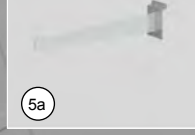

5a

Cascade pour slotwall 12", 18"



5c

Cascade à crochet pour slotwall



5e

Tablette 11"p X 1m L

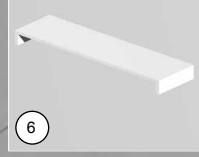

6

Support à vêtement dos-à-dos

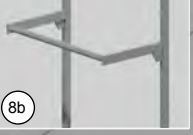

8b

CHOIX DE COULEURS



Noir Blanc Rouge Jaune Bleu foncé Bleu pâle Vert

PVC et VELCRO

MOBILIER

Présentoirs à documents

Spécifications

1. Présentoir à publications
2. Distributeur des jounaux
3. Porte-brochure en plexiglas # 162
4. Porte-brochure Click 3 tablettes en stainless # 161
5. Tablettes inclinées en plexiglas pour slotwall
6. présentoir à documents en plastique
7. Tablette Click inclinée à 45°
8. Porte-documents CLICK

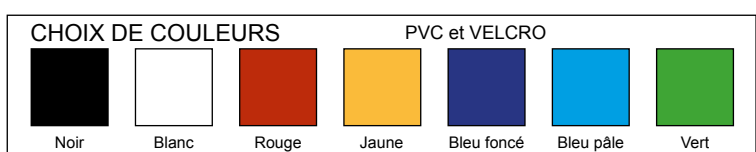
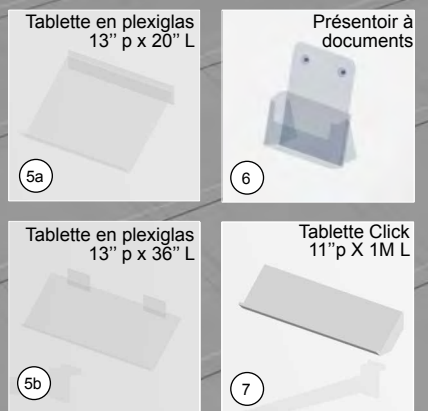

Vestiare & Miroir Mobile

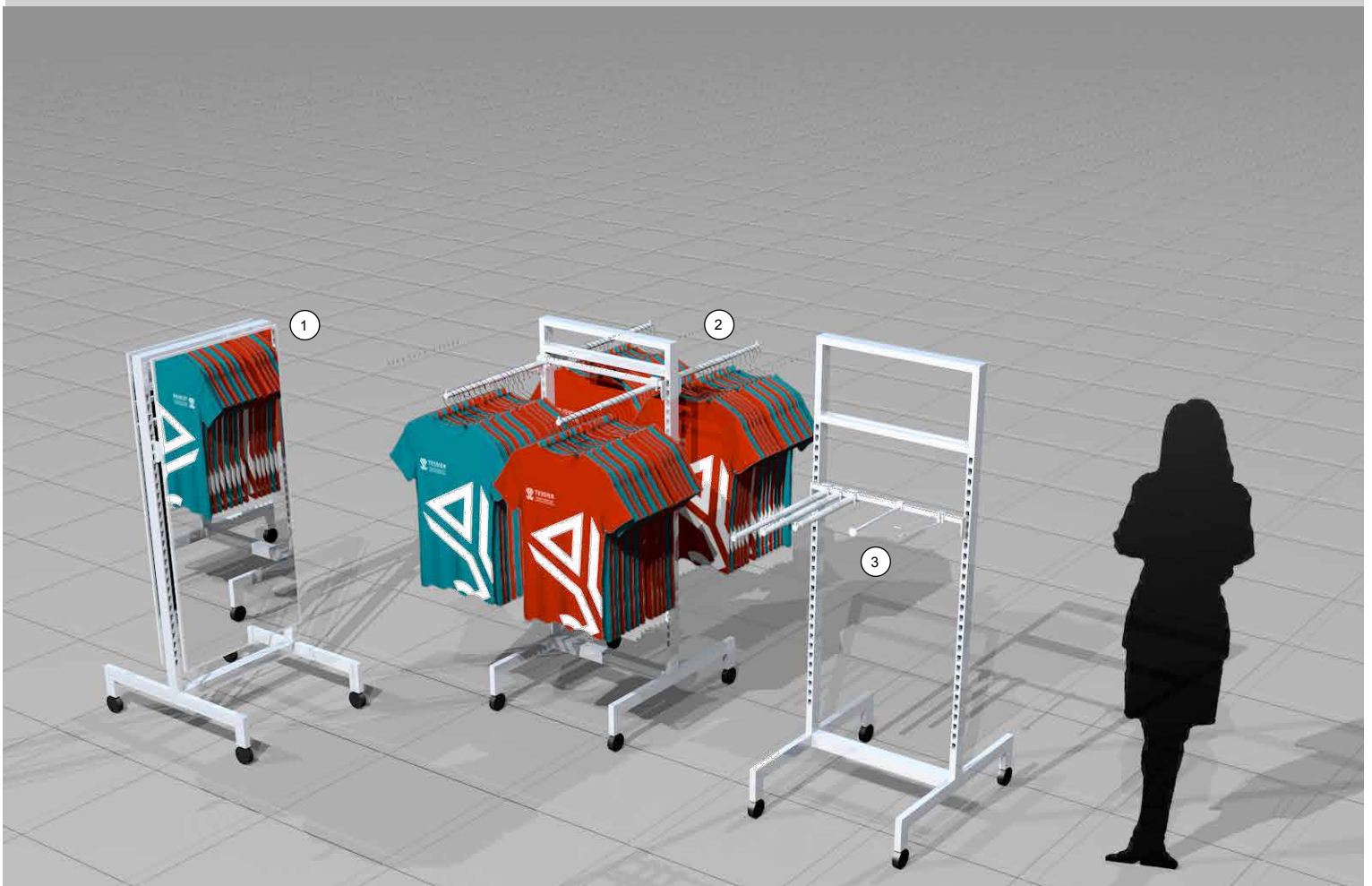

Spécifications

1. Mobile miroir recto-verso 32" x 25" x 61" (H)
2. Vestiare Mobile - capable de tenir 60 articles de vêtements en même temps 32" x 25" x hauteur ajustable 61" - 68"
3. Accessoires pour Vestiare Mobile
 - 3a. Petit support à vêtement 12"
 - 3b. Crochet pour accessoires 10"
 - 3c. Support à vêtements ajustables à 14", 18" & 22"

Petit support à vêtement 12"



3a

Crochet pour accessoires 10"



3b

Support à vêtements ajustable à 14", 18" & 22"



3c

MOBILIER

Signalisation et Modèles de tour

Spécifications

1. Tour Click, hauteur: 11,5', base: 0,5m x 0,5m x 8', module du haut: 1m x 1m x 42"
2. Tour Click slotwall, hauteur: 11,5', base: 1m x 1m x 8', module du haut: 1m x 1m x 42" à 45 degrés
3. Tour Click, hauteur: 11,5', base: 1m x 1m x 8' avec porte, module du haut rond: 1mdr x 1mdr x 42"
4. Tour Click, hauteur: 19,5', base: 2m x m x 8' avec comptoirs, module du haut rond: 1mdr x 2m x 42"
5. Tour Click, hauteur: 11,5', base: 1m x 1m x 8' avec comptoirs, module du haut rond: 1mdr x 1mdr x 42"
6. Tour Click, hauteur: 10', base ronde: 1m rayon x 8', module du haut rond: 2m rayon x 14"
7. Tour Click, hauteur: 11,5', base vitrée: 0,5md x 0,5md x 8' avec porte, module du haut rond: 2m rayon x 42"
8. Tour Click, hauteur: 10,5', base hexagonale de 0,5m x 8', module du haut rond: 2m rayon x 30"
9. Borne de signalisation directionnelle, fascia 0,5m x 14" soutenue par une boîte à fleur 0,5m x 0,5m
10. Borne de signalisation directionnelle, fascia 0,5m x 24"

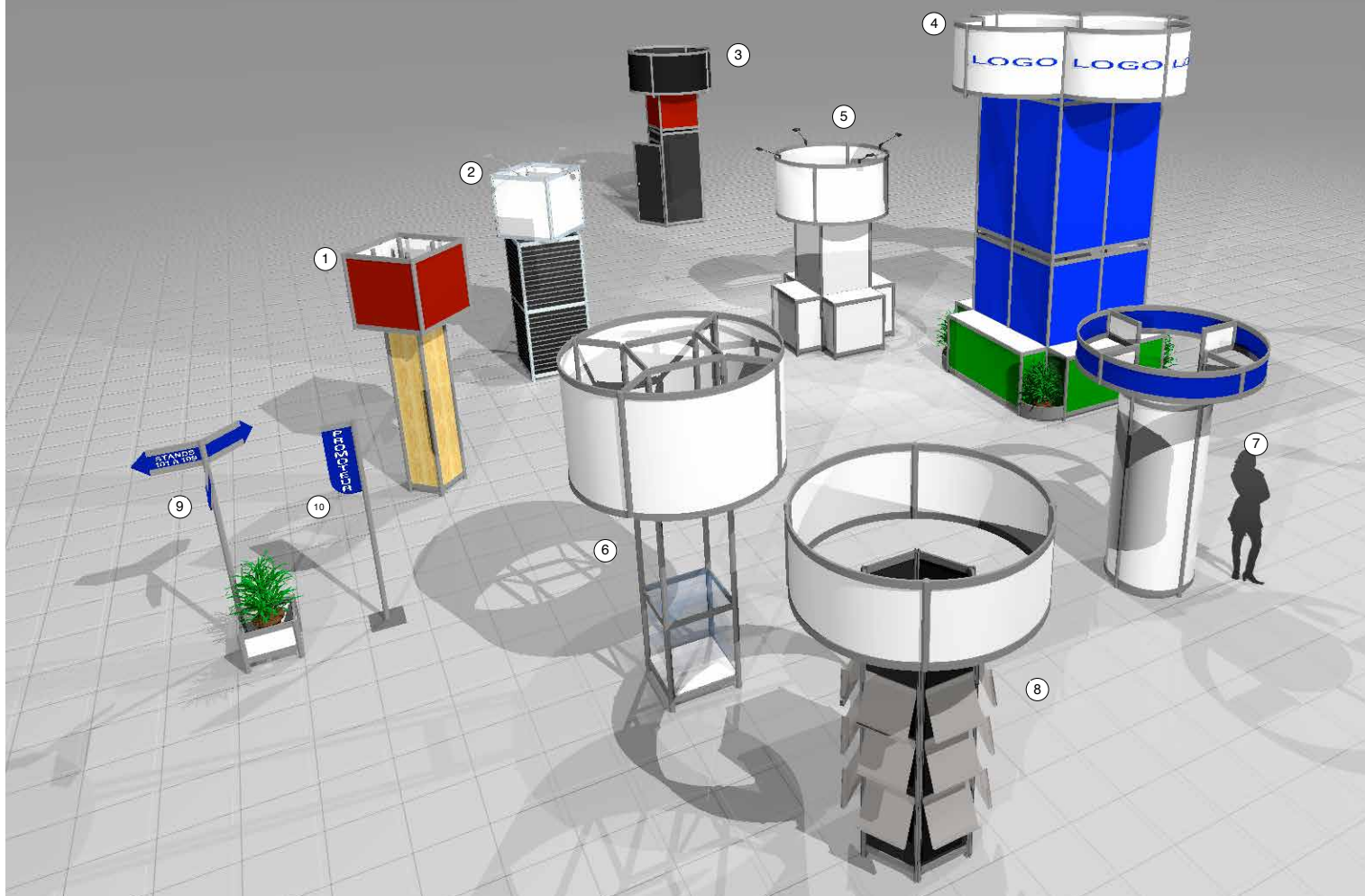

CHOIX DE COULEURS

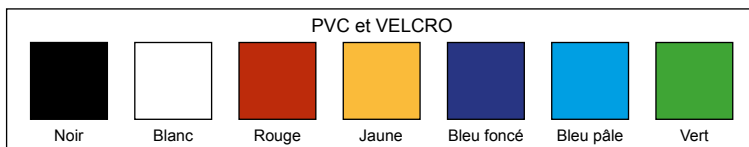

Comptoirs Spécialisés

Spécifications

1. Pupitre d'orateur noir, blanc et fini bois
2. Comptoir de dégustation avec miroir
3. Comptoir vitré 2/3 1m x 0.5m x 42" (H)
4. Comptoir vitré dessus 1mdr x 42" (H)
5. Comptoir vitré dessus 1m x 0.5m x 42" (H)
6. Cloche en plexiglass 0.5md x 42" (H) & 0.5m x 42" (H)
7. Présentoir de musée 1m x 0.5m x 42" (H) & 0.5md x 0.5m x 42" (H)

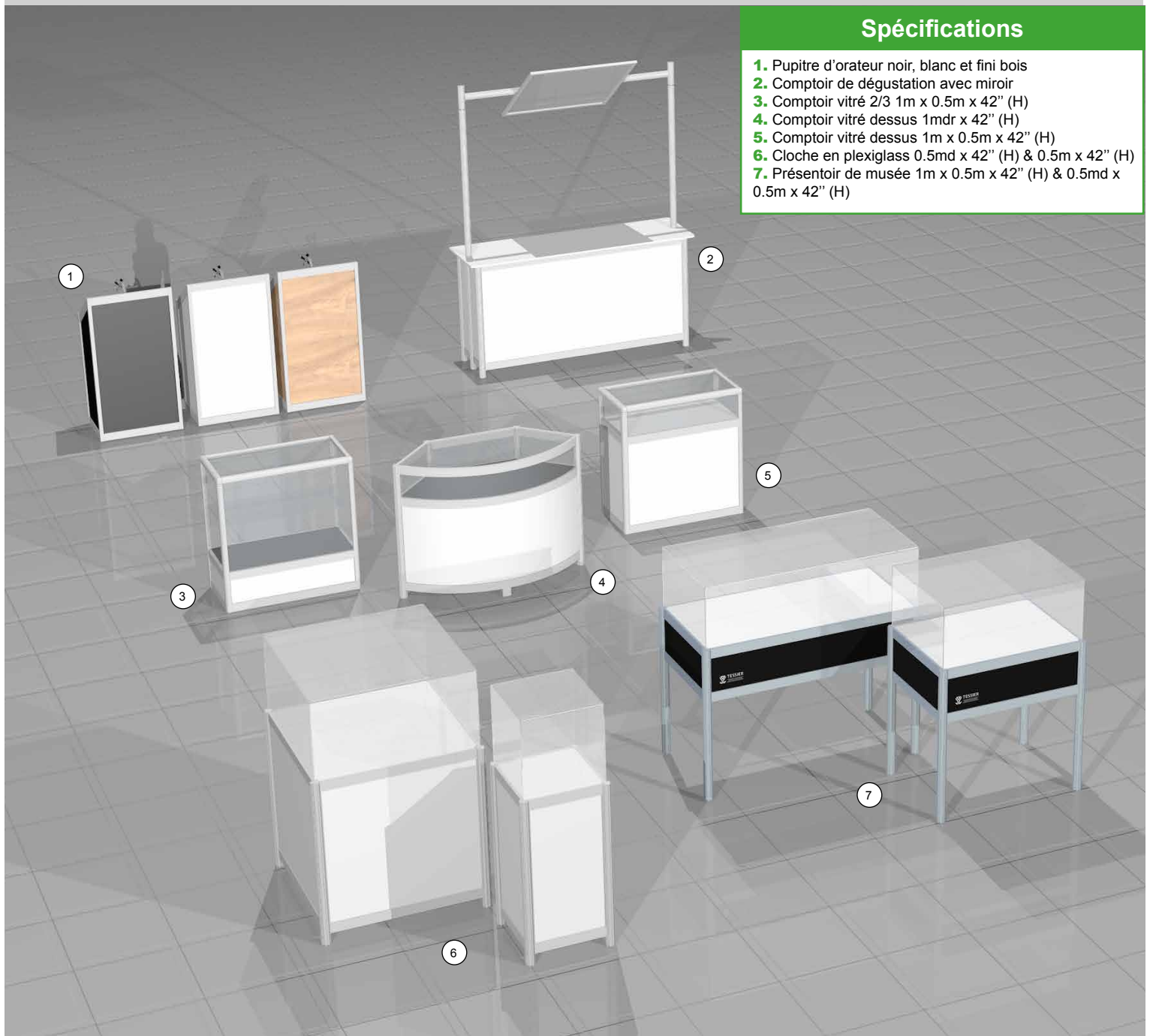

CHOIX DE COULEURS

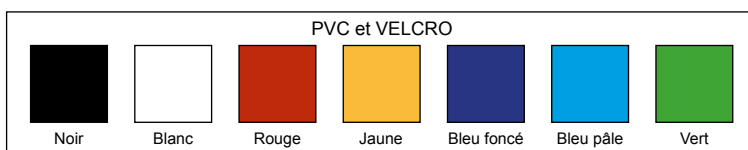

MOBILIER

Sièges

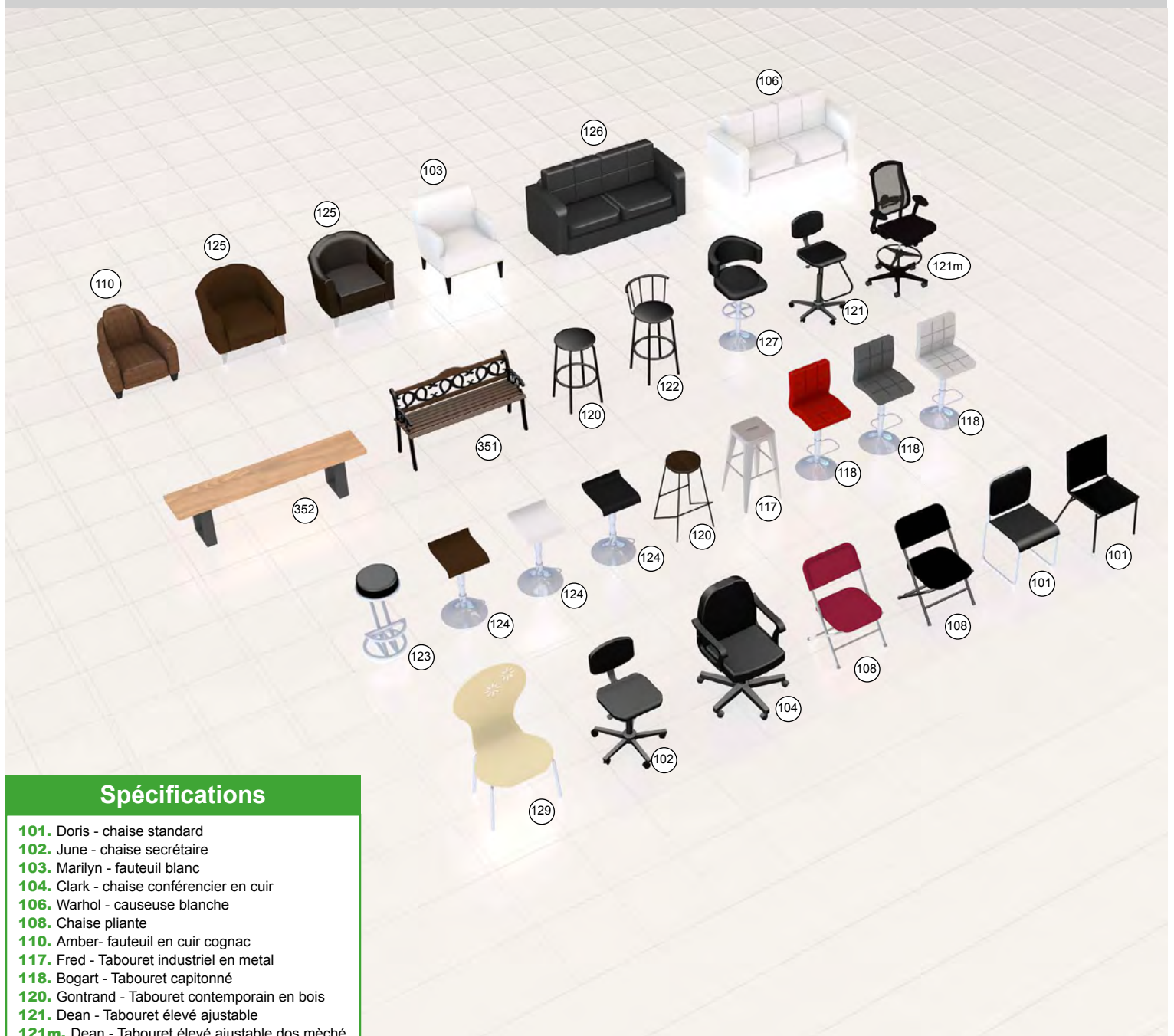

Spécifications

- 101.** Doris - chaise standard
- 102.** June - chaise secrétaire
- 103.** Marilyn - fauteuil blanc
- 104.** Clark - chaise conférencier en cuir
- 106.** Warhol - causeuse blanche
- 108.** Chaise pliante
- 110.** Amber- fauteuil en cuir cognac
- 117.** Fred - Tabouret industriel en metal
- 118.** Bogart - Tabouret capitonné
- 120.** Gontrand - Tabouret contemporain en bois
- 121.** Dean - Tabouret élevé ajustable
- 121m.** Dean - Tabouret élevé ajustable dos mèche
- 122.** Tabouret bistro
- 123.** Jayne - Tabouret design rond
- 124.** Brigitte - Tabouret design carré
- 125.** Churchill - Fauteuil en cuir
- 126.** Andy - Causeuse en cuir
- 127.** Marlon - Tabouret en cuir noir exécutif
- 129.** Monroe - Chaise fleur érable
- 351.** Banc de parc
- 352.** Paul - Banc en bois d'Acacia

MOBILIER

Tables

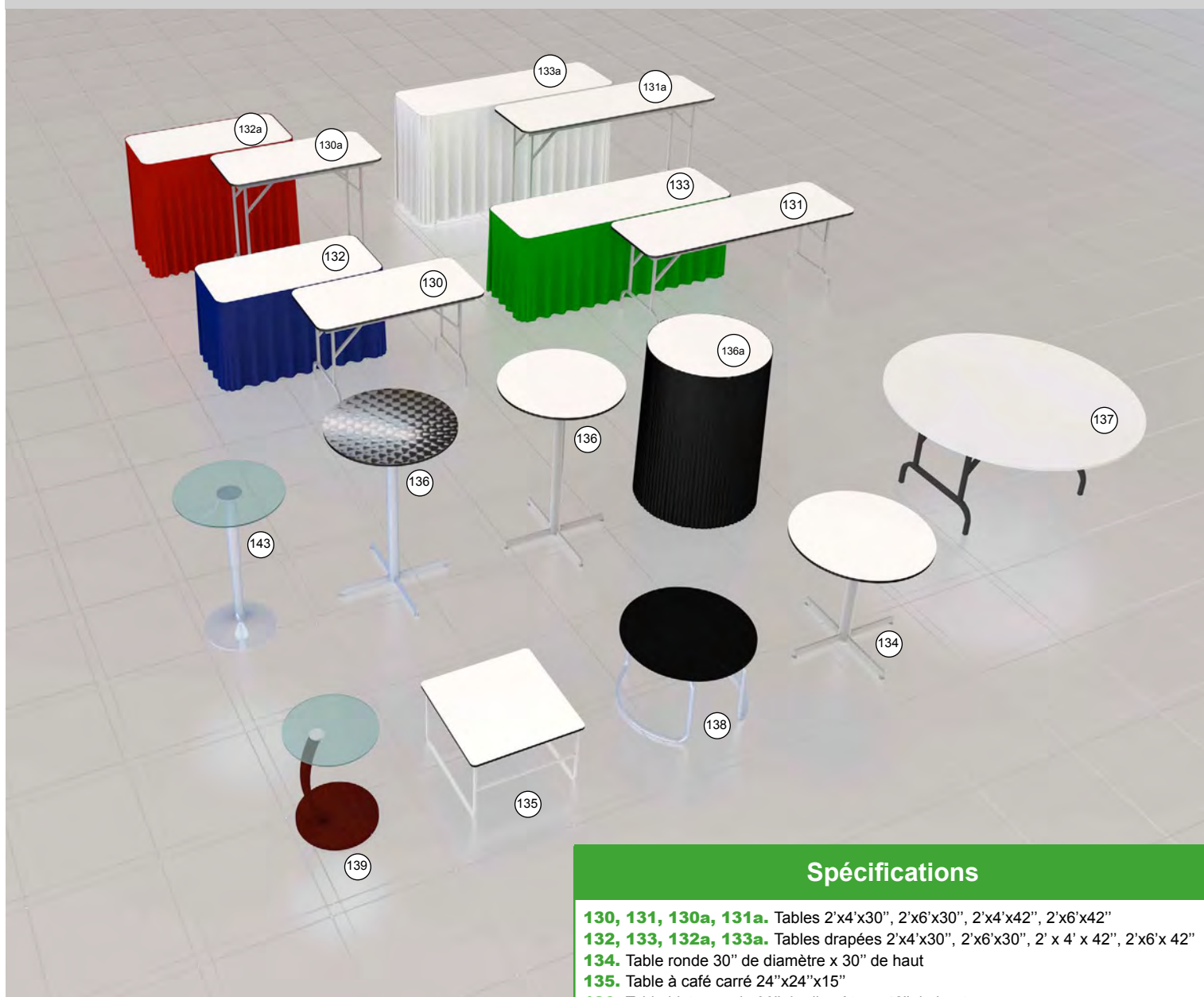

Spécifications

- 130, 131, 130a, 131a.** Tables 2'x4'x30", 2'x6'x30", 2'x4'x42", 2'x6'x42"
- 132, 133, 132a, 133a.** Tables drapées 2'x4'x30", 2'x6'x30", 2' x 4' x 42", 2'x6'x 42"
- 134.** Table ronde 30" de diamètre x 30" de haut
- 135.** Table à café carré 24"x24"x15"
- 136.** Table bistro ronde 30" de diamètre x 42" de haut
- 136a.** Table drapée bistro ronde 30" de diamètre x 42" de haut
- 137.** Table ronde 60" de diamètre x 30" de haut
- 138.** Table à café ronde 24"x24"x16"
- 139.** Table d'appoint en verre ronde

CHOIX DE COULEURS

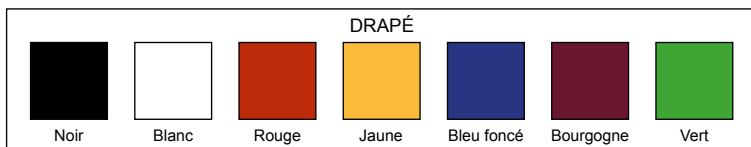

MOBILIER

Portes-bannière mobiles

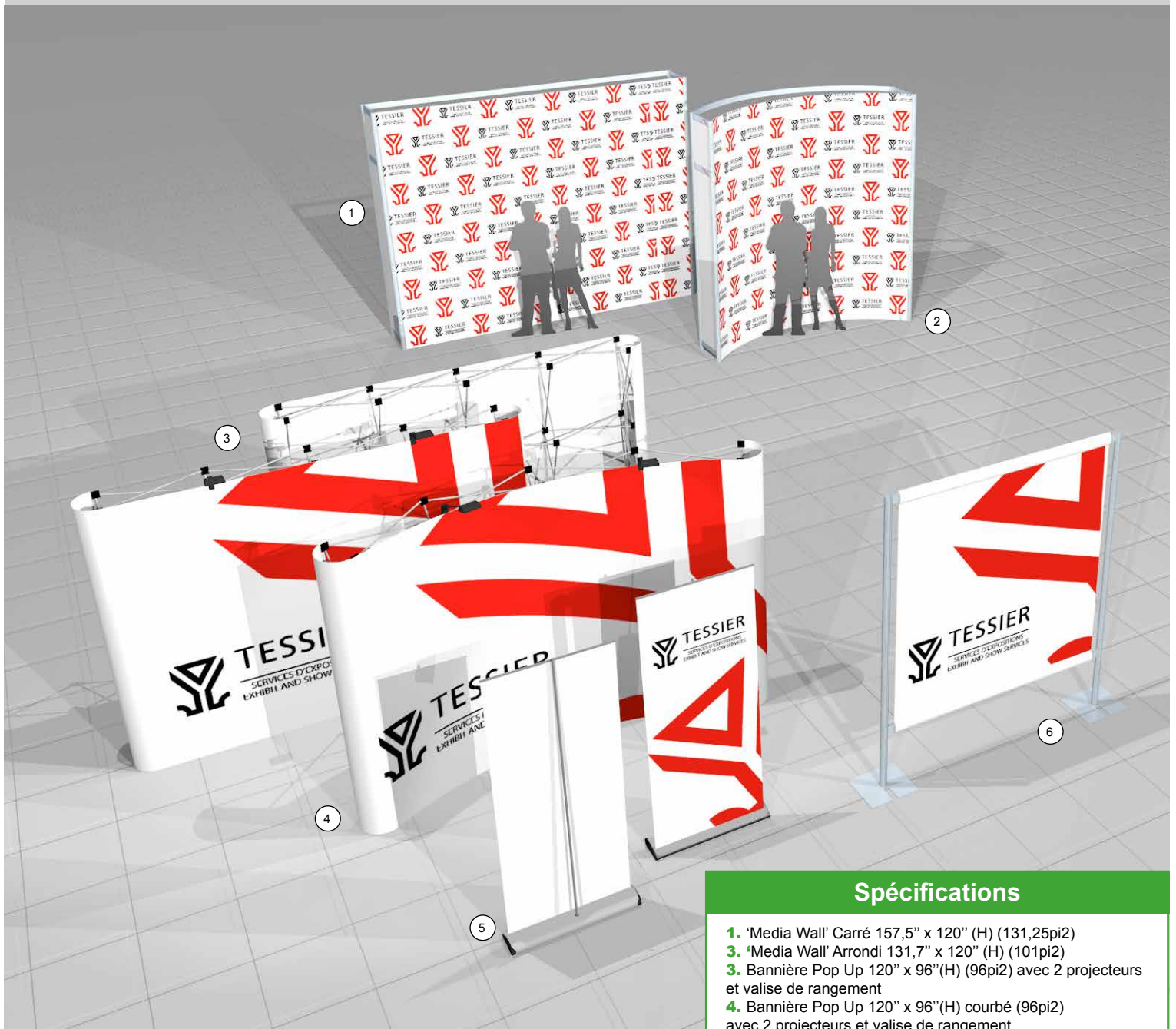

Spécifications

1. 'Media Wall' Carré 157,5" x 120" (H) (131,25pi2)
3. 'Media Wall' Arrondi 131,7" x 120" (H) (101pi2)
3. Bannière Pop Up 120" x 96" (H) (96pi2) avec 2 projecteurs et valise de rangement
4. Bannière Pop Up 120" x 96" (H) courbé (96pi2) avec 2 projecteurs et valise de rangement
5. Support à bannière rétractable (Roll-up) 31,5" x 78,5" (H) (17,2pi2) avec sac de rangement
6. Système Click et bannière de tissu ajustable en hauteur et en largeur